



Company profile

WELLOO was founded in 2012. It is a high-quality tool brand with novel product design and high cost performance. Its products gradually cover hand tools, power tools, measuring tools, garden tools, small machinery and other categories. It is deeply loved by customers in the Middle East, Southeast Asia and Africa markets. .

We are committed to perfect tool solutions through integration of the supply chain and continuous technological development. Every WELLOO product has undergone rigorous testing to provide workers with a better experience.



WELLOO®



+ CLD50212.1 12V 1500mAh
LI-ION CORDLESS DRILL



x1

ITEM NO.	CLD50212.1
Voltage	12V
No-load Speed	0-350/0-1350rpm
Charge time	1 Hour
Battery Capacity	1500mAh
Max.Torque	25N.m
Chuck Size	0.8-10mm

+ CLD50212 12V 1500mAh
LI-ION CORDLESS DRILL



x2

ITEM NO.	CLD50212
Voltage	12V
No-load Speed	0-350/0-1350rpm
Charge time	1 Hour
Battery Capacity	1500mAh
Max.Torque	25N.m
Chuck Size	0.8-10mm

+ CLD50221 21V 1500mAh
LI-ION CORDLESS DRILL



x2

ITEM NO.	CLD50221
Voltage	21V
No-load Speed	0-350/0-1350rpm
Charge time	1 Hour
Battery Capacity	1500mAh
Max.Torque	29N.m
Chuck Size	0.8-10mm

+ CID50221T 21V 2000mAh
LI-ION CORDLESS IMPACT DRILL
BRUSHLESS



ITEM NO.	CID50221T
Voltage	21V
No-load Speed	0-1100rpm
Impact Rate	0-4400bpm
Battery Capacity	2000mAh
Max.Torque	55N.m
Chuck Size	0.8-13mm

+ PCH16802 21V 4000mAh
LI-ION CORDLESS ROTARY HAMMER



x2

ITEM NO.	PCH16802
Voltage	21V
No-load Speed	0-1100rpm
Impact Rate	0-4400bpm
Battery Capacity	4000mAh
Max drill dia.	13mm for steel 20mm for concrete

+ CAG50421 21V 4000mAh
LI-ION CORDLESS ANGLE GRINDER



x2

ITEM NO.	CAG50421
Voltage	21V
No-load Speed	0-4500/5500/7000rpm
Charge time	2-3 Hour
Battery Capacity	4000mAh
Wheel Dia.	115mm

+ SCS23015 4V 1500mAh
LI-ION CORDLESS SCREWDRIVER SET



x1

ITEM NO.	SCS23015
Voltage	4V
No-load Speed	250rpm
Battery Capacity	1500mAh
Max.Torque	3.5N.m

+ PCW15808 12V 1500mAh
LI-ION CORDLESS RATCHET WRENCH



x2

ITEM NO.	PCW15808
Voltage	12V
No-load Speed	280rpm
Squar Drive	3/8", 1/4"
Battery Capacity	1500mAh
Charge Time	1Hour
Max Torque	30N.m

+ PCW28908 21V 4000mAh
LI-ION CORDLESS IMPACT WRENCH



x2

ITEM NO.	PCW28908
Voltage	21V
No-load Speed	0-1600/0-2200rpm
Battery Capacity	4000mAh
Max.Chuck Capacity	4-22mm
Max.Torque	320N.m



Li-ion
TECHNOLOGY

**PROFESSIONAL
LI-ION CORDLESS TOOLS**



ITEM NO.	PCJ25810
Voltage	20V
No-load Speed	0-2800rpm
Stroke Length	20mm
Battery Capacity	2000mAh
Cutting Capacity	65mm for wood



ITEM NO.	PCS35806
Voltage	20V
No-load Speed	0-4500rpm
Diameter	165mm
Battery Capacity	2000mAh
Vertical Cutting Depth	0-55mm



ITEM NO.	PCS15807
Voltage	20V
No-load Speed	0-2800rpm
Stroke Length	20mm
Battery Capacity	2000mAh
Cutting Capacity	5mm for steel plate 150mm for wood



More 20V share battery power tools increasing.....



ITEM NO.	PCS15802
Voltage	20V
Stroke Length	15mm
Battery Capacity	2000mAh
No-load Speed	0-2800rpm
Cutting Capacity	5mm for steel plate 65mm for wood



ITEM NO.	PCB16601
Voltage	20V
No-load Speed	0-8000/10000/15500rpm
Battery Capacity	2000mAh
Wind Volume	2.8m³/min
Accessories	Dust Collect Bag



ITEM NO.	PCL16650
Voltage	20V
Wattage	20W
Lumens	1500Lm-180W
Battery Capacity	2000mAh
Working Time	2Hrs



AGD63100C
720W 100mm
ANGLE GRINDER



ITEM NO.	AGD63100C
Rated Voltage	220-240V~50/60Hz
Rate Power	720W
No-load Speed	11000r/min
Spindle	M10
Wheel Size	100mm

AGD63100
760W 100mm
ANGLE GRINDER



ITEM NO.	AGD63100
Rated Voltage	220-240V~50/60Hz
Rate Power	760W
No-load Speed	11000r/min
Spindle	M10
Wheel Size	100mm

AGD63100A
800W 100mm
ANGLE GRINDER



ITEM NO.	AGD63100A
Rated Voltage	220-240V~50/60Hz
Rate Power	800W
No-load Speed	10000r/min
Spindle	M10
Wheel Size	100mm

AGD63115
760W 115mm
ANGLE GRINDER



ITEM NO.	AGD63115
Rated Voltage	220-240V~50/60Hz
Rate Power	760W
No-load Speed	11000r/min
Spindle	M14
Wheel Size	115mm

AGD64115
850W 115mm
ANGLE GRINDER



ITEM NO.	AGD64115
Rated Voltage	220-240V~50/60Hz
Rate Power	850W
No-load Speed	11000r/min
Spindle	M14
Wheel Size	115mm

AGD63100L
720W 100mm
ANGLE GRINDER



ITEM NO.	AGD63100L
Rated Voltage	220-240V~50/60Hz
Rate Power	720W
No-load Speed	11000r/min
Spindle	M10
Wheel Size	100mm

AGD65125
1200W 125mm
ANGLE GRINDER



ITEM NO.	AGD65125
Rated Voltage	220-240V~50/60Hz
Rate Power	1200W
No-load Speed	0-11000r/min
Spindle	M14
Wheel Size	125mm

AGD68180
2350W 180mm
ANGLE GRINDER



ITEM NO.	AGD68180
Rated Voltage	220-240V~50/60Hz
Rate Power	2350W
No-load Speed	8000r/min
Spindle	M14
Wheel Size	180mm

AGD69180
2400W 180mm
ANGLE GRINDER



ITEM NO.	AGD69180
Rated Voltage	220-240V~50/60Hz
Rate Power	2400W
No-load Speed	6500r/min
Spindle	M14
Wheel Size	180mm

AGD69230
2400W 230mm
ANGLE GRINDER



ITEM NO.	AGD69230
Rated Voltage	220-240V~50/60Hz
Rate Power	2400W
No-load Speed	6500r/min
Spindle	M14
Wheel Size	230mm

PLS64180
1400W 180mm
POLISHER



ITEM NO.	PLS64180
Rated Voltage	220-240V~50/60Hz
Rate Power	1400W
No-load Speed	1000-3300r/min
Spindle	M14
Dise Dia	180mm

DG61353
135W 3.2mm
 MINI DIE GRINDER SET **218 PCS**



ITEM NO.	DG61353
Rated Voltage	220~240V/50/60Hz
Rate Power	135W
No-load Speed	0-33000/min
Max. Out. Dia	3.2mm

DG63206
320W 6mm
 DIE GRINDER



ITEM NO.	DG63206
Rated Voltage	220~240V/50/60Hz
Rate Power	320W
No-load Speed	0-33000/min
Max. Out. Dia	6mm

DG66006
600W 6mm
 DIE GRINDER



ITEM NO.	DG66006
Rated Voltage	220~240V/50/60Hz
Rate Power	600W
No-load Speed	30000r/min
Max. Out. Dia	6mm

EPD91400
400W 6.5mm
 ELECTRIC DRILL



ITEM NO.	EPD91400
Rated Voltage	220~240V/50~60Hz
Rate Power	400W
No-load Speed	4200r/min
Chuck Size	6.5mm

EPD91500
500W 10mm
 ELECTRIC DRILL



ITEM NO.	EPD91500
Rated Voltage	220~240V/50~60Hz
Rate Power	500W
No-load Speed	0-3300r/min
Chuck Size	10mm

EPD92550
550W 10mm
 ELECTRIC DRILL



Two-stage deceleration

ITEM NO.	EPD92550
Rated Voltage	220~240V/50~60Hz
Rate Power	550W
No-load Speed	0-2000r/min
Chuck Size	10mm

IPD92550
550W 13mm
 IMPACT DRILL



ITEM NO.	IPD92550
Rated Voltage	220~240V/50~60Hz
Rate Power	550W
No-load Speed	0-2800r/min
Chuck Size	13mm

IPD91550
550W 13mm
 IMPACT DRILL



ITEM NO.	IPD91550
Rated Voltage	220~240V/50~60Hz
Rate Power	550W
No-load Speed	0-3000r/min
Chuck Size	13mm

IPD91810
810W 13mm
 IMPACT DRILL



ITEM NO.	IPD91810
Rated Voltage	220~240V/50/60Hz
Rate Power	810W
No-load Speed	0-2800r/min
Chuck Size	13mm

IPD92710
710W 13mm
 IMPACT DRILL



ITEM NO.	IPD92710
Rated Voltage	220~240V/50~60Hz
Rate Power	710W
No-load Speed	0-2600r/min
Chuck Size	13mm

SDR60500
500W 6mm
 SCREW DRIVER



ITEM NO.	SDR60500
Rated Voltage	220~240V/50~60Hz
Rate Power	500W
No-load Speed	0-2050r/min
Chuck Size	6mm(1/4")

ESD60280
280W 10mm
 SCREWDRIVER DRILL



ITEM NO.	ESD60280
Rated Voltage	220~240V/50~60Hz
Rate Power	280W
No-load Speed	0-750r/min
Chuck Size	10mm

DEMOLITION BREAKER



1800W

RHML7022
600W 22mm
ROTARY HAMMER



SDS plus

ITEM NO.	RHML7022
Rated Voltage	220-240V/50-60Hz
Rate Power	600W
No-load Speed	850r/min
Impact Rated	5100b/min
Drill Diamete	22mm

RHML7026
800W 26mm
ROTARY HAMMER



SDS plus

ITEM NO.	RHML7026
Rated Voltage	220-240V-50/60Hz
Rate Power	800W
No-load Speed	1180r/min
Impact Rated	5100b/min
Drill Diameter	26mm for concrete

RHM72602
850W 26mm
ROTARY HAMMER



SDS plus

ITEM NO.	RHM72602
Rated Voltage	220-240V-50-60Hz
Rate Power	850W
No-load Speed	800r/min
Impact Rated	4500b/min
Drill Diameter	26mm for concrete

RHM72803
1050W 28mm
ROTARY HAMMER



3-FUNCTION
SDS plus

ITEM NO.	RHM72803
Rated Voltage	220-240V-50/60Hz
Rate Power	1050W
No-load Speed	920r/min
Impact Rated	4350b/min
Impact Joules	5J
Drill Diameter	28mm for concrete

RHM73201V
1500W 32mm
ROTARY HAMMER



3-FUNCTION
SDS plus

ITEM NO.	RHM73201V
Rated Voltage	220-240V-50-60Hz
Rate Power	1500W
No-load Speed	850r/min
Impact Rated	4250b/min
Impact Joules	5J
Drill Diameter	32mm for concrete

DBK80810
1100W 10J
DEMOLITION BREAKER



HEX

ITEM NO.	DBK80810
Rated Voltage	220V-50Hz
Rate Power	1100W
Impact Rated	3000bpm
Impact Joules	10J

DBK85030
850W 13.5J
DEMOLITION BREAKER



HEX

ITEM NO.	DBK85030
Rated Voltage	220V-50Hz
Rate Power	850W
Impact Rated	3750b/min
Impact Joules	13.5J

DBK85035
1300W 15J
DEMOLITION BREAKER



HEX

ITEM NO.	DBK85035
Rated Voltage	220V-50Hz
Rate Power	1300W
Impact Rated	4000bpm
Impact Joules	15J

DBK8511E
1800W 25J
DEMOLITION BREAKER



SDS max

ITEM NO.	DBK8511E
Rated Voltage	220V-50Hz
Rate Power	1800W
Impact Rated	1000-1900b/min
Impact Joules	25J

DBK85065
1500W 45J
DEMOLITION BREAKER



HEX

ITEM NO.	DBK85065
Rated Voltage	220V-50Hz
Rate Power	1500W
Impact Rated	1700b/min
Impact Joules	45J

DBK85085
1700W 55J
DEMOLITION BREAKER



HEX

ITEM NO.	DBK85085
Rated Voltage	220V-50Hz
Rate Power	1700W
Impact Rated	1900b/min
Impact Joules	55J

DBK85095
1800W 60J
DEMOLITION BREAKER



HEX

ITEM NO.	DBK85095
Rated Voltage	220V-50Hz
Rate Power	1800W
Impact Rated	1850b/min
Impact Joules	60J



ITEM NO.	CSW56185
Rated Voltage	220-240V/50-60Hz
Rate Power	1380W
No-load Speed	5300r/min
Blade size	185mm/7"
Cutting depth	44mm at 45° /65mm at 90°



ITEM NO.	CSW56235
Rated Voltage	220-240V/50-60Hz
Rate Power	2100W
No-load Speed	4500r/min
Blade size	235mm/9"
Cutting depth	56mm at 45° /85mm at 90°



ITEM NO.	LTM33706
Rated Voltage	220-240V/50-60Hz
Rate Power	600W
No-load Speed	32000r/min
Max Blade Dia.	6mm&1/4"



ITEM NO.	JSG32710
Rated Voltage	220-240V/50-60Hz
Rate Power	710W
No-load Speed	0-3000r/min
Cutting Capacity	65mm for wood 8mm for metal
Miter cuts:	up to 45° (left and right)



ITEM NO.	JSG31085
Rated Voltage	220-240V/50-60Hz
Rate Power	800W
No-load Speed	500-2600r/min
Cutting Capacity	100mm for wood 10mm for metal
Miter cuts:	up to 45° (left and right)



ITEM NO.	EPL38201E
Rated Voltage	220-240V/50-60Hz
Rate Power	500W
No-load Speed	15800r/min
Planing Width	82mm
Planing Depth	1mm



ITEM NO.	EPL38201A
Rated Voltage	220-240V/50-60Hz
Rate Power	850W
No-load Speed	16500r/min
Planing Width	82mm
Planing Depth	1mm



ITEM NO.	EPL38202
Rated Voltage	220-240V/50-60Hz
Rate Power	710W
No-load Speed	16500r/min
Planing Width	82mm
Planing Depth	2mm



ITEM NO.	EPL39002
Rated Voltage	220-240V/50-60Hz
Rate Power	1020W
No-load Speed	13000r/min
Planing Width	90mm
Planing Depth	2mm



ITEM NO.	ERT36127
Rated Voltage	220-240V/50-60Hz
Rate Power	1600W
No-load Speed	23000r/min
Chuck Dia.	12.7mm



ITEM NO.	ERT3612
Rated Voltage	220-240V/50-60Hz
Rate Power	2200W
No-load Speed	9000-23500r/min
Chuck Dia.	12mm



ITEM NO.	ERT3612C
Rated Voltage	220-240V/50-60Hz
Rate Power	2100W
No-load Speed	8000-23500r/min
Chuck Dia.	12mm & 1/2"

PSD25110
240W 110x110mm
 PALM SANDER



ITEM NO.	PSD25110
Rated Voltage	220-240V/50-60Hz
Rate Power	240W
No-load Speed	14500r/min
Base size	110x110mm

FSD25180
320W 180x90mm
 FINISH SANDER



ITEM NO.	FSD25180
Rated Voltage	220-240V/50-60Hz
Rate Power	320W
No-load Speed	14000r/min
Base size	180x90mm

BSD25610
1200W 100x610mm
 BELT SANDER



ITEM NO.	BSD25610
Rated Voltage	220-240V/50-60Hz
Rate Power	1200W
No-load Speed	500r/min
Belt size	100x610mm

EBW32400
400W 2.5m³/min
 ELECTRIC BLOWER



ITEM NO.	EBW32400
Rated Voltage	220-240V/50-60Hz
Rate Power	400W
No-load Speed	13000r/min
Air Volume	2.5m³/min

EBW32600
600W 2.8m³/min
 ELECTRIC BLOWER



Adjustable speed

ITEM NO.	EBW32600
Rated Voltage	220-240V/50-60Hz
Rate Power	600W
No-load Speed	0-14000r/min
Air Volume	2.8m³/min

EBW32650
650W 3.5m³/min
 ELECTRIC BLOWER



Adjustable speed

ITEM NO.	EBW32650
Rated Voltage	220-240V/50-60Hz
Rate Power	650W
No-load Speed	3000-16000r/min
Air Volume	3.5m³/min



MCT65110
1400W 110mm
MARBLE CUTTER



ITEM NO.	MCT65110
Rated Voltage	220-240V/50-60Hz
Rate Power	1400W
No-load Speed	14200r/min
Blade size	110mm
Cutting depth	34mm

WLC61125
1600W 125mm
WALL CHISEL



ITEM NO.	WLC61125
Rated Voltage	220-240V/50-60Hz
Rate Power	1600W
No-load Speed	9000r/min
Blade size	125mm
Cutting depth	35mm

WLC62035
2800W 80mm
WALL CHISEL



ITEM NO.	WLC62035
Rated Voltage	220-240V/50-60Hz
Rate Power	2800W
No-load Speed	1900r/min
Blade size	80mm
Cutting depth	35mm

HTG41200A
2000W 0-300/0-650°C
HOT AIR GUN



ITEM NO.	HTG41200A
Rated Voltage	220-240V/50-60Hz
Rate Power	2000W
Temperate	0-300/0-650°C
Air Flow	240/450l/min

PTW07032
700W
PLASTIC TUBE WELDING TOOLS



ITEM NO.	PTW07032
Rated Voltage	220-240V/50-60Hz
Thermoregulator	0-300°C
Input Power	700W
With Heating Sockets	20/25/32mm

PTW07063
800/1500W
PLASTIC TUBE WELDING TOOLS



ITEM NO.	PTW07063
Rated Voltage	220-240V/50-60Hz
Thermoregulator	0-300°C
Input Power	800/1500W
With Heating Sockets	20/25/32/40/50/63mm

ESG15400
400W 850ml/min
ELECTRIC SPRAY GUN



ITEM NO.	ESG15400
Rated Voltage	220-240V/50-60Hz
Rate Power	400W
Max. Viscosity	60din/sec
Max Flow	850ml/min
Nozzle	φ1.8/2.6mm
Paint Reservoir	800ml

ESG15550
550W 850ml/min
ELECTRIC SPRAY GUN



ITEM NO.	ESG15550
Rated Voltage	220-240V/50-60Hz
Rate Power	550W
Max. Viscosity	80din/sec
Max Flow	850ml/min
Nozzle	φ1.8/2.6mm
Paint Reservoir	800ml

ESG13110
110W 300ml/min
ELECTRIC SPRAY GUN



ITEM NO.	ESG13110
Rated Voltage	220-240V/50-60Hz
Rate Power	110W
Max. Viscosity	60din/sec
Max Flow	300ml/min
Nozzle	φ0.8mm
Paint Reservoir	800ml

ESG15800
800W 900ml/min
ELECTRIC SPRAY GUN



ITEM NO.	ESG15800
Rated Voltage	220-240V/50-60Hz
Rate Power	800W
Max. Viscosity	80din/sec
Max Flow	900ml/min
Nozzle	φ1.8/2.6mm
Paint Reservoir	800ml

LSL6055G
5 line Green light
LASER LEVEL



ITEM NO.	LSL6055G
Wave Lengh	520nm
Accuracy	10m±2mm
Battery Capacity	4000mAh
Endurance	4Hrs

LDM1540 / LDM1570
40m/70m
LASER DISTANCE METER



ITEM NO.	LDM1540	LDM1570
Measuring range	0.05-40m	0.05-70m
Measuring accuracy	±2mm	±2mm
Laser type	620-690nm, <1mW	620-690nm, <1mW
Spirit level, Area	Spirit level, Area	Spirit level, Area
Volume measurement	Volume measurement	Volume measurement
Battery	2*AA battery 5000times	2*AA battery 5000times



MX21400
1400W 14mm
MIXER

ITEM NO.	MX21400
Rated Voltage	220-240V/50-60Hz
Rate Power	1400W
No-Load Speed	0-900r/min
Spindle	M14



WSD22701
750W 180mm
DRYWALL SANDER

ITEM NO.	WSD22701
Rated Voltage	220-240V/50-60Hz
Rate Power	750W
No-Load Speed	1300-2500rpm
Grinding Dia	180mm



WSD21802
800W 215mm
DRYWALL SANDER

ITEM NO.	WSD21802
Voltage	220-240V/50-60Hz
Rate Input Power	800W
No Load Speed	1000-1600rpm
Grinding Dia	215mm
Length	180cm



EVB81035
800W 35mm
ELECTRIC VIBRATOR

ITEM NO.	EVB81035
Input Voltage	220-240V/50-60Hz
Rated Power	800W
No-load Speed	4600r/min
Dia of Vibrating Head	35mm



EVB82050
1500W 50mm
ELECTRIC VIBRATOR

ITEM NO.	EVB82050
Input Voltage	220-240V-50Hz
Rated Power	1500W
No-load Speed	0-2850r/min
Dia of Vibrating Head	50mm



VST85035/VST85050
35mm/50mm
VIBRATOR SHAFT

ITEM NO.	VST85035	VST85050
Diameter	35mm	50mm
Frequency	200Hz	183Hz
Amplitude	0.8mm	1.0mm
Shaft Diameter	10mm	13mm



DCD50118
1600W 130mm
DIAMOND CORE DRILL

ITEM NO.	DCD50118
Input Voltage	220-240V/50-60Hz
Max Drill Dia	118mm
Rated Power	1600W
No-load Speed	0-2100r/min



DCD50168
2300W 168mm
DIAMOND CORE DRILL

ITEM NO.	DCD50168
Input Voltage	220-240V/50-60Hz
Max Drill Dia	168mm
Rated Power	2300W
No-load Speed	0-1400r/min



DCD50205
3200W 205mm
DIAMOND CORE DRILL

ITEM NO.	DCD50205
Input Voltage	220-240V/50-60Hz
Max Drill Dia	205mm
Rated Power	3200W
No-load Speed	700r/min



HPW61160
1600W 100bar
HIGH PRESSURE WASHER

ITEM NO.	HPW61160
Rated Voltage	220-240V-50/60Hz
Rate Power	1600W
No-load Speed	6.5L/min
Working Pressure	60bar
Max Pressure	100bar
Degree of Protection	IPX5



HPW62200
2000W 150bar
HIGH PRESSURE WASHER

ITEM NO.	HPW62200
Rated Voltage	220-240V-50/60Hz
Rate Power	2000W
No-load Speed	6L/min
Working Pressure	100bar
Max Pressure	150bar
Degree of Protection	IPX5



HPW63165
1650W 135bar
HIGH PRESSURE WASHER

ITEM NO.	HPW63165
Rated Voltage	220-240V-50/60Hz
Rate Power	1650W
No-load Speed	5L/min
Working Pressure	90bar
Max Pressure	135bar
Degree of Protection	IPX5

+ **MTS61255P**
1100W 255mm
MITER SAW



ITEM NO.	MTS61255P
Rated Voltage	220~240V/50~60Hz
Rate Power	1100W
No-load Speed	6000r/min
Max Blade Dia.	255mm/10"
Cutting Capacity	(0°X90°): 70*140mm

+ **MTS61255**
2200W 255mm
MITER SAW



ITEM NO.	MTS61255
Rated Voltage	220~240V/50~60Hz
Rate Power	2200W
No-load Speed	4500r/min
Max Blade Dia.	255mm/10"
Cutting Capacity	(0°X90°): 70*140mm

+ **MTS61255L**
2200W 255mm
MITER SAW



ITEM NO.	MTS61255L
Rated Voltage	220~240V/50~60Hz
Rate Power	2200W
No-load Speed	5000r/min
Max Blade Dia.	255mm/10"
Cutting Capacity	(90°X90°): 70*305mm (90°X45°): 70*200mm (45°X90°): 43*305mm (45°X45°): 43*200mm

+ **CTS65350**
2600W 355mm
CUT-OFF SAW



ITEM NO.	CTS65350
Rated Voltage	220~240V/50~60Hz
Rate Power	2600W
No-load Speed	3900r/min
Max Blade Dia.	355mm/14"

+ **CTS65355**
2300W 355mm
CUT-OFF SAW



ITEM NO.	CTS65355
Rated Voltage	220~240V/50~60Hz
Rate Power	2300W
No-load Speed	3900r/min
Max Blade Dia.	355mm/14"

+ **CTS65355H**
2300W 355mm
CUT-OFF SAW



ITEM NO.	CTS65355H
Rated Voltage	220~240V/50~60Hz
Rate Power	2300W
No-load Speed	4000r/min
Max Blade Dia.	355mm/14"

+ **CTS65400**
2200W 400mm
CUT-OFF SAW



ITEM NO.	CTS65400
Input Voltage	220V~50Hz
Rated Power	2200W
No-load Speed	2840r/min
Blade Size	400mm/16"

+ **CTS65400-3**
3000W 400mm
CUT-OFF SAW



ITEM NO.	CTS65400-3
Input Voltage	380V~50Hz
Rated Power	3000W
No-load Speed	2840r/min
Blade Size	400mm/16"

+ **TCT32601A**
600/800/1000/1200mm
TILE CUTTER



ITEM NO.	TCT32601A
Max Cutting Width	600/800/1000/1200mm
Min Cutting Width	35mm
Available Thickness	6-15mm
Bottom Plate Width	20cm

BGD65125
150W 125mm
BENCH GRINDER



ITEM NO.	BGD65125
Input Voltage	220-240V~50Hz
Rated Power	150W
No-load Speed	2840r/min
Wheel Size	125mm/5"

BGD65150
250W 150mm
BENCH GRINDER



ITEM NO.	BGD65150
Input Voltage	220-240V~50Hz
Rated Power	250W
No-load Speed	0-2840r/min
Wheel Size	150mm/6"

BGD65200
370W 200mm
BENCH GRINDER



ITEM NO.	BGD65200
Input Voltage	220-240V~50Hz
Rated Power	370W
No-load Speed	0-2840r/min
Wheel Size	200mm/8"

DPS67130
350W 13mm
DRILL PRESS



ITEM NO.	DPS67130
Rated Voltage	220-240V~50Hz
Max Drilling Diameter	13mm(1/2")
Motor Power	350W
Chuck Capacity	1.5-13mm
Spindle Travel	50mm
Class Of Speed	5
No-Load Speed-50Hz	620-2620r/min
Spindle Taper	B16
Max. Distance From Spindle Axis To Surface Of Column	105mm
Max. Distance From Spindle End To Surface Of Table	220mm
Max. Distance From Spindle End To Surface Of Base	300mm
Swing	210mm
Table Size	160x160mm
Base Size	300x195mm
Column Diameter	46mm
Height	580mm
Net Weight/Gross Weigh	16/17kg

DPS67160
550W 16mm
DRILL PRESS



ITEM NO.	DPS67160
Rated Voltage	220-240V~50Hz
Max Drilling Diameter	16mm(5/8")
Motor Power	550w
Chuck Capacity	3-16mm
Spindle Travel	80mm
Class Of Speed	16
No-Load Speed-50Hz	180-2770r/min
Spindle Taper	MT2
Max. Distance From Spindle Axis To Surface Of Column	162.5mm
Max. Distance From Spindle End To Surface Of Table	450mm
Max. Distance From Spindle End To Surface Of Base	630mm
Swing	325mm
Table Size	290x290mm
Base Size	420x250mm
Column Diameter	72mm
Height	980mm
Net Weight/Gross Weigh	42/45kg

DPS67200
750W 20mm
DRILL PRESS



ITEM NO.	DPS67200
Rated Voltage	220-240V~50Hz
Max Drilling Diameter	20mm(3/4")
Motor Power	750w
Chuck Capacity	5-20mm
Spindle Travel	85mm
Class Of Speed	16
No-Load Speed-50Hz	180-2770r/min
Spindle Taper	MT2
Max. Distance From Spindle Axis To Surface Of Column	180mm
Max. Distance From Spindle End To Surface Of Table	620mm
Max. Distance From Spindle End To Surface Of Base	810mm
Swing	360mm
Table Size	290x290mm
Base Size	460x270mm
Column Diameter	72mm
Height	1200mm
Net Weight/Gross Weigh	58/60kg



DW-MMA120
120A
INVERTER WELDING MACHINE



ITEM NO.	DW-MMA120
Input Voltage	220-240V~50/60Hz
Rated Input Capacity	4.8KVA
Max No-load Voltage	35-50V
Current Range	120A/1.6-2.5MM
Rated Duty Cycle	35%
Protection Degree	IP21S
Insulation Class	F

DW-MMA140S
140A
INVERTER WELDING MACHINE



ITEM NO.	DW-MMA140S
Input Voltage	220-240V~50/60Hz
Rated Input Capacity	5.8KVA
Max No-load Voltage	35-50V
Current Range	140A/1.6-3.2MM
Rated Duty Cycle	35%
Protection Degree	IP21S
Insulation Class	F

DW-MMA160S
160A
INVERTER WELDING MACHINE



ITEM NO.	DW-MMA160S
Input Voltage	220-240V~50/60Hz
Rated Input Capacity	7.6KVA
Max No-load Voltage	35-50V
Current Range	160A/1.6-4.0MM
Rated Duty Cycle	60%
Protection Degree	IP21S
Insulation Class	F

DW-MMA210S
210A
INVERTER WELDING MACHINE



ITEM NO.	DW-MMA210S
Input Voltage	220-240V~50/60Hz
Rated Input Capacity	9.6KVA
Max No-load Voltage	35-50V
Current Range	210A/1.6-4.0MM
Rated Duty Cycle	40%
Protection Degree	IP21S
Insulation Class	F

WD-MMA145
145A
INVERTER WELDING MACHINE



ITEM NO.	WD-MMA145
Input Voltage	220-240V~50/60Hz
Rated Input Capacity	5.4KVA
Max No-load Voltage	70V
Current Range	145A/0.8-3.2MM
Rated Duty Cycle	60%
Protection Degree	IP21S
Insulation Class	F

WD-MMA160
160A
INVERTER WELDING MACHINE



ITEM NO.	WD-MMA160
Input Voltage	220-240V~50/60Hz
Rated Input Capacity	5.8KVA
Max No-load Voltage	70V
Current Range	0-160A/0.8-3.2MM
Rated Duty Cycle	60%
Protection Degree	IP21S
Insulation Class	F

WD-MMA200
200A
INVERTER WELDING MACHINE



ITEM NO.	WD-MMA200
Input Voltage	220-240V~50/60Hz
Rated Input Capacity	9.6KVA
Max No-load Voltage	65-75V
Current Range	0-200A/0.8-4.0MM
Rated Duty Cycle	60%
Protection Degree	IP21S
Insulation Class	F

WD-MMA250
250A
INVERTER WELDING MACHINE



ITEM NO.	WD-MMA250
Input Voltage	220-240V~50/60Hz
Rated Input Capacity	11KVA
Max No-load Voltage	70V
Current Range	0-250A/0.8-5.0MM
Rated Duty Cycle	60%
Protection Degree	IP21S
Insulation Class	F

WD-MMA400
400A
INVERTER WELDING MACHINE



ITEM NO.	WD-MMA400
Input Voltage	380V~50/60Hz
Rated Input Capacity	18.5KVA
Max No-load Voltage	75V
Current Range	0-400A/0.8-5.0MM
Rated Duty Cycle	60%
Protection Degree	IP21S
Insulation Class	F

+ **WD-MAG/MIG250**
40-250A
INVERTER WELDING MACHINE



ITEM NO.	WD-MAG/MIG250
Input Voltage	220-380V~50/60Hz
Rated Input Capacity	6.8KVA
Max No-load Voltage	62-54V
Current Range	0-200A/40-250A/0.8-1.0MM
Rated Duty Cycle	60%
Protection Degree	IP21S
Insulation Class	F

+ **WD-MAG/MIG400**
50-400A
INVERTER WELDING MACHINE



ITEM NO.	WD-MAG/MIG400
Input Voltage	380V~50/60Hz
Rated Input Capacity	15.3KVA
Max No-load Voltage	68V
Current Range	0-400A/50-400A/1.0-1.2MM
Rated Duty Cycle	60%
Protection Degree	IP21S
Insulation Class	F

+ **WD-CUT40**
40A CUT 10mm(steel)
PLASMA CUTTING MACHINE



ITEM NO.	WD-CUT40
Input Voltage	220-240V~50/60Hz
Rated Input Capacity	8KVA
Max No-load Voltage	308V
Current Range	20-40A Cut 10mm(steel)
Rated Duty Cycle	60%
Protection Degree	IP21S
Insulation Class	F

INVERTER WELDING MACHINE

IGBT TECHNOLOGY



QB1060
370W 35L/min
PERIPHERAL PUMP



ITEM NO.	QB1060
Rated Voltage	220-240V~50Hz
Rate Power	370W/0.5HP
Max Flow	35L/min
Max Head	35m
Max Suction	8m
Inlet/Outlet	1"X1"

QB1080
750W 60L/min
PERIPHERAL PUMP



ITEM NO.	QB1080
Rated Voltage	220-240V~50Hz
Rate Power	750W/1HP
Max Flow	60L/min
Max Head	35m
Max Suction	8m
Inlet/Outlet	1"X1"

CPM10158
750W 120L/min
CENTRIFUGAL PUMP



ITEM NO.	CPM10158
Rated Voltage	220-240V~50Hz
Rate Power	750W/1HP
Max Flow	120L/min
Max Head	30m
Max Suction	8m
Inlet/Outlet	1"X1"

JET10100B
750W 65L/min
SELF-PERIPHERAL PUMP



ITEM NO.	JET10100B
Rated Voltage	220-240V~50Hz
Rate Power	750W/1HP
Max Flow	65L/min
Max Head	45m
Max Suction	8m
Inlet/Outlet	1"X1"

ZDB10350
370W 36L/min
SELF-PERIPHERAL PUMP



ITEM NO.	ZDB10350
Rated Voltage	220-240V~50Hz
Rate Power	370W/0.5HP
Max Flow	36L/min
Max Head	35m
Max Suction	8m
Inlet/Outlet	1"X1"

AK10130
370W 1.9m³/H
AUTOMATIC SELF-PRIMING
PERIPHERAL PUMP



ITEM NO.	AK10130
Rated Voltage	220-240V~50Hz
Rate Power	370W/0.5HP
Max Flow	36L/min
Max Head	30m
Max Suct	8m
Inlet/Outlet	1"X1"

QDX15370 / QDX15750
370W / 750W
PERIPHERAL PUMP



ITEM NO.	QDX15370	QDX15750
Rated Voltage	220-240V~50Hz	220-240V~50Hz
Rate Power	370W/0.5HP	750W/1.0HP
Max Flow	6.2m³/h	7.2m³/h
Max Head	18m	32m
Inlet/Outlet	1"	1"

DWP4370 / DWP4550 / DWP4750
4" DEEP WELL PUMP



ITEM NO.	DWP4370	DWP4370	DWP4370
Rated Voltage	220-240V~50Hz	220-240V~50Hz	220-240V~50Hz
Rate Power	370W/0.5HP	550W/0.75HP	750W/1.0HP
Max Flow	6m³/h	6m³/h	6m³/h
Max Head	46m	60m	78m
Inlet/Outlet	1"	1"	1"

DWP41100 / DWP41500
4" DEEP WELL PUMP



ITEM NO.	DWP41100	DWP41500
Rated Voltage	220-240V~50Hz	220-240V~50Hz
Rate Power	1100W/1.5HP	1500W/2.0HP
Max Flow	6m³/h	6m³/h
Max Head	110m	130m
Inlet/Outlet	1"	1"



**Max Flow
High Power**

+ ECS30216
1400W 16"
 ELECTRIC CHAIN SAW



ITEM NO.	ECS30216
Rated Voltage	220-240V/50-60Hz
Rate Power	1400W
Chain Speed	600m/min
Bar length	16"

+ GCS2512
900W 25cc
 GASOLINE CHAIN SAW



ITEM NO.	GCS2512
Engine Type	1-Cylinder, 2-Stroke
Displacement	25cc
Rate Power	900W
Fuel tank capacity	230ml
Bar Length	12"

+ GCS5818
2300W 58cc
 GASOLINE CHAIN SAW



ITEM NO.	GCS5818
Engine Type	1-Cylinder, 2-Stroke
Displacement	58cc
Rate Power	2300W
Fuel tank capacity	550ml
Bar Length	18"

+ GCS5822
2300W 58cc
 GASOLINE CHAIN SAW



ITEM NO.	GCS5822
Engine Type	1-Cylinder, 2-Stroke
Displacement	58cc
Rate Power	2300W
Fuel tank capacity	550ml
Bar Length	22"

+ GCS5818A
2300W 58cc
 GASOLINE CHAIN SAW



ITEM NO.	GCS5818A
Engine Type	1-Cylinder, 2-Stroke
Displacement	58cc
Rate Power	2300W
Fuel tank capacity	550ml
Bar Length	18"

+ GCS5822A
2300W 58cc
 GASOLINE CHAIN SAW



ITEM NO.	GCS5822A
Engine Type	1-Cylinder, 2-Stroke
Displacement	58cc
Rate Power	2300W
Fuel tank capacity	550ml
Bar Length	22"

+ GCS5822C
2300W 58cc
 GASOLINE CHAIN SAW



ITEM NO.	GCS5822C
Engine Type	1-Cylinder, 2-Stroke
Displacement	58cc
Rate Power	2300W
Fuel tank capacity	550ml
Bar Length	22"

+ GHT75260
750W 22.5cc
 GASOLINE HEDGE TRIMMER



ITEM NO.	GHT75260
Engine Type	1-Cylinder, 2-Stroke
Displacement	22.5cc
Rate Power	750W
Fuel tank capacity	230ml
Pruning Length	600mm

+ GBC40-5
1400W 43cc
 GASOLINE BRUSH CUTTER



ITEM NO.	GBC40-5
Engine Type	1E40F-5, 2-Stroke
Displacement	43cc
Rate Power	1400W
OIL/Fuel Ratio	1:30
Pole Dia.	28mm

+ GBC44-5
1700W 51.7cc
 GASOLINE BRUSH CUTTER



ITEM NO.	GBC44-5
Engine Type	1E44F-5, 2-Stroke
Displacement	51.7cc
Rate Power	1700W
OIL/Fuel Ratio	1:30
Pole Dia.	28mm

+ GBC139
800W 31cc
 GASOLINE BRUSH CUTTER



ITEM NO.	GBC139
Engine Type	139F, 4-Stroke
Displacement	31cc
Rate Power	800W
OIL/Fuel Ratio	/
Pole Dia.	26mm
Cutting Tools	metal blade, nylon head

+ GBC139B
800W 31cc
 GASOLINE BRUSH CUTTER



ITEM NO.	GBC139B
Engine Type	139F, 4-Stroke
Displacement	31cc
Rate Power	800W
OIL/Fuel Ratio	/
Pole Dia.	26mm
Cutting Tools	metal blade, nylon head

+ GSG83600
2.8/3.0KW 208cc
 GASOLINE GENERATOR



ITEM NO.	GSG83600
Rated AC Voltage	220V~ 50Hz
Rated/Max Output	2.8/3.0KW
Voltage regulator	AVR
Rated Speed	3000RPM
Displacement	208CC
Start System	Recoil
Fuel Tank Capacity	15

+ GSG86500
5.0/5.5KW 389cc
 GASOLINE GENERATOR



ITEM NO.	GSG86500
Rated AC Voltage	220V~ 50Hz
Rated/Max Output	5.0/5.5KW
Voltage regulator	AVR
Rated Speed	3000RPM
Displacement	389CC
Start System	Electric +Recoil
Fuel Tank Capacity	25

+ GSG89500
7.0/7.5KW 439cc
 GASOLINE GENERATOR



ITEM NO.	ACP20246
Rated AC Voltage	220V~ 50Hz
Rated/Max Output	7.0/7.5KW
Voltage regulator	AVR
Rated Speed	3000RPM
Displacement	439CC
Start System	Electric + Recoil
Fuel Tank Capacity	25

+ SDG85000
5.0KW
 SILENT DIESEL GENERATOR



ITEM NO.	SDG85000
Rated AC Voltage	220V~ 50Hz
Rated/Max Output	5/5.5KW
Voltage regulator	AVR
Rated Speed	3000RPM
Displacement	418CC
Start System	Electric
Fuel Tank Capacity	16

+ GWP850
212cc/7HP 2"
 GASOLINE WATER PUMP



ITEM NO.	GWP850
Inlet/Outlet	2Inch(50mm)
Displacement	212CC
Horse Power	7.0HP/3600RPM
Max Lift Head	32m
Max Flow	32m³
Max Suction	7m
Fuel Tank Capacity	3.6L

+ GWP880
212cc/7HP 3"
 GASOLINE WATER PUMP



ITEM NO.	GWP880
Inlet/Outlet	3Inch(80mm)
Displacement	212CC
Horse Power	7.0HP/3600RPM
Max Lift Head	30m
Max Flow	56m³
Max Suction	7m
Fuel Tank Capacity	3.6L

+ **ACP2024**
750W/1HP 24L
AIR COMPRESSOR



ITEM NO.	ACP2024
Rated Voltage	220~240V~50Hz
Rate Power	0.75KW(1.0HP)
Rate Speed	2850r/min
Max Pressure	8Bar
Tank Capacity	24L

+ **ACP2050**
1500W/2HP 50L
AIR COMPRESSOR



ITEM NO.	ACP2050
Rated Voltage	220~240V~50Hz
Rate Power	1.5KW(2.0HP)
Rate Speed	2850r/min
Max Pressure	8Bar
Tank Capacity	50L

+ **ACP2124S**
1500W/2HP 24L
AIR COMPRESSOR



ITEM NO.	ACP2124S
Rated Voltage	220~240V~50Hz
Rate Power	1.5KW(2.0HP)
Rate Speed	2850r/min
Max Pressure	8Bar
Tank Capacity	24L

+ **ACP2150S**
2000W/2.5HP 50L
AIR COMPRESSOR



ITEM NO.	ACP2150S
Rated Voltage	220~240V~50Hz
Rate Power	2.0KW(2.5HP)
Rate Speed	2850r/min
Max Pressure	8Bar
Tank Capacity	50L

+ **ACP22100B**
2200KW/3HP 100L
AIR COMPRESSOR



ITEM NO.	ACP22100B
Rated Voltage	220~240V~50Hz
Rate Power	2.2KW(3.0HP)
Rate Speed	987r/min
Max Pressure	8Bar
Tank Capacity	100L

+ **ACP22200B**
3000W/4HP 200L
AIR COMPRESSOR



ITEM NO.	ACP22200B
Rated Voltage	220~240V~50Hz
Rate Power	3.0KW(4.0HP)
Rate Speed	1050r/min
Max Pressure	8Bar
Tank Capacity	200L

ACP22300B
4000W/5.5HP 300L
 AIR COMPRESSOR



ITEM NO.	ACP22300B
Rated Voltage	220~240V~50Hz
Rate Power	4.0KW(5.5HP)
Rate Speed	791r/min
Max Pressure	8Bar
Tank Capacity	300L

ACP2380I
1500W/2HP 80L
 AIR COMPRESSOR



ITEM NO.	ACP2380I
Rated Voltage	220~240V~50Hz
Rate Power	1.5KW(2.0HP)
Rate Speed	987r/min
Max Pressure	8Bar
Tank Capacity	80L

ACP23100I
2200W/3HP 100L
 AIR COMPRESSOR



ITEM NO.	ACP23100I
Rated Voltage	220~240V~50Hz
Rate Power	2.2KW(3.0HP)
Rate Speed	987r/min
Max Pressure	8Bar
Tank Capacity	100L

ACP23150I
2200W/3HP 150L
 AIR COMPRESSOR



ITEM NO.	ACP23150I
Rated Voltage	220~240V~50Hz
Rate Power	2.2KW(3.0HP)
Rate Speed	987r/min
Max Pressure	8Bar
Tank Capacity	150L

ACP23200I
2200KW/3HP 200L
 AIR COMPRESSOR



ITEM NO.	ACP22100B
Rated Voltage	220~240V~50Hz
Rate Power	2.2KW(3.0HP)
Rate Speed	987r/min
Max Pressure	8Bar
Tank Capacity	200L

ENJOY YOUR AIR TOOLS





ANG1013J
6-13mm
AIR STAPLER

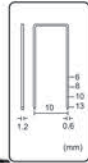

ITEM NO.	ANG1013J
Working pressure	0.4-0.7MPa
Capacity	100PCS
Nail length	6-13mm
Nail type	U type
Weight	0.85KG



ANGF30
10-30mm
AIR NAILER

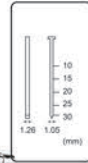

ITEM NO.	ANGF30
Working pressure	0.45-0.7MPa
Capacity	100PCS
Nail length	10-30mm
Nail type	Straight type
Weight	1.1KG



ANGF50
25-50mm
AIR NAILER

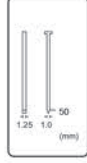

ITEM NO.	ANGF50
Working pressure	0.45-0.8MPa
Capacity	100PCS
Nail length	25-50mm
Nail type	Straight type
Weight	1.3KG



ANGT50
25-50mm
AIR NAILER

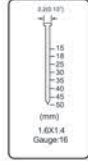

ITEM NO.	ANGT50
Working pressure	0.45-0.7MPa
Capacity	100PCS
Nail length	25-50mm
Nail type	Straight type
Weight	1.1KG



ANGST64
10-64mm
AIR NAILER

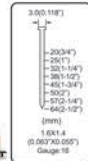

ITEM NO.	ANGST64
Working pressure	0.45-0.7MPa
Capacity	100PCS
Nail length	10-64mm
Nail type	Straight type
Weight	3KG



ASG827
600cc
AIR SPRAY GUN

ITEM NO.	ASG827
Standard Nozzle	1.4mm
Working Pressure	2-3.5Bar
Air Consumption	6-11.0cfm
Paint Width	160-260mm
Paint Tank	600cc



ASG162S
1000cc
AIR SPRAY GUN

ITEM NO.	ASG162S
Standard Nozzle	1.5mm
Working Pressure	3-4Bar
Air Consumption	5.0cfm
Paint Width	110-220mm
Paint Tank	1000cc



ASG4001
1000cc
AIR SPRAY GUN

ITEM NO.	ASG4001
Standard Nozzle	1.8mm
Working Pressure	3.5-5Bar
Air Consumption	5-7cfm
Paint Width	160-240mm
Paint Tank	1000cc



ASGF75S
750cc
AIR SPRAY GUN

ITEM NO.	ASGF75S
Standard Nozzle	1.5mm
Working Pressure	3.5-5Bar
Air Consumption	6-12cfm
Paint Width	110-180mm
Paint Tank	750cc



ASGF75G
300cc
AIR SPRAY GUN

ITEM NO.	ASGF75G
Standard Nozzle	1.5mm
Working Pressure	3.5-5Bar
Air Consumption	6-12.0cfm
Paint Width	110-180mm
Paint Tank	300cc



APW72160
570N.m
AIR IMPACT WRENCH

ITEM NO.	APW72160
Free Speed	7000rpm
Square Drive	1/2"
Air Consumption	7.2cfm
Torque	570N.m



APW73340
1355N.m
AIR IMPACT WRENCH

ITEM NO.	APW73340
Free Speed	7000rpm
Square Drive	3/4"
Air Consumption	7.2cfm
Torque	1355N.m

+ MINI COMBINATION PLIERS



ITEM NO.	SIZE	QTY/CTN
MCP04501	5"/125mm	120

+ MINI CUTTING PLIERS



ITEM NO.	SIZE	QTY/CTN
MCP04502	5"/125mm	120

+ MINI NOSE PLIERS



ITEM NO.	SIZE	QTY/CTN
MCP04503	5"/125mm	120

+ END CUTTING PLIERS



ITEM NO.	SIZE	QTY/CTN
ECP22160	6"/160mm	60
ECP22200	8"/200mm	48

+ COMBINATION PLIERS



ITEM NO.	SIZE	QTY/CTN
HCP18160	6"/160mm	120
HCP18180	7"/180mm	60
HCP18200	8"/200mm	60

+ CUTTING PLIERS



ITEM NO.	SIZE	QTY/CTN
DCP18160	6"/160mm	120
DCP18200	8"/200mm	60

+ LONG NOSE PLIERS



ITEM NO.	SIZE	QTY/CTN
HNP18160	6"/160mm	120
HNP18200	8"/200mm	60

+ TOWER PINCER



ITEM NO.	SIZE	QTY/CTN
HTP23230	9"/230mm	60

+ COMBINATION PLIERS



ITEM NO.	SIZE	QTY/CTN
HCP19160	6"/160mm	60
HCP19180	7"/180mm	60
HCP19200	8"/200mm	60

+ CUTTING PLIERS



ITEM NO.	SIZE	QTY/CTN
DCP19160	6"/160mm	60
DCP19200	8"/200mm	60

+ LONG NOSE PLIERS



ITEM NO.	SIZE	QTY/CTN
HNP19160	6"/160mm	60
HNP19200	8"/200mm	60

+ CARPENTER PLIERS



ITEM NO.	SIZE	QTY/CTN
HCP23200	8"/200mm	60

+ INSULATION COMBINATION PLIERS



ITEM NO.	SIZE	QTY/CTN
HCP20160	6"/160mm	60
HCP20180	7"/180mm	60
HCP20200	8"/200mm	60

+ INSULATION CUTTING PLIERS



ITEM NO.	SIZE	QTY/CTN
DCP20160	6"/160mm	60
DCP20200	8"/200mm	60

+ INSULATION NOSE PLIERS



ITEM NO.	SIZE	QTY/CTN
HNP20160	6"/160mm	60
HNP20200	8"/200mm	60

+ LOCKING PLIERS C CLAMP



ITEM NO.	SIZE	QTY/CTN
HLP26105	11"/280mm	36

+ LOCKING PLIERS



ITEM NO.	SIZE	QTY/CTN
HLP26101	10"/260mm	48

+ LOCKING PLIERS RUBBER HANDLE



ITEM NO.	SIZE	QTY/CTN
HLP26102	10"/260mm	48

+ LOCKING PLIERS CRV



ITEM NO.	SIZE	QTY/CTN
HLP26103	10"/260mm	48

+ LOCKING PLIERS D TYPE



ITEM NO.	SIZE	QTY/CTN
HLP26104	10"/260mm	48



ITEM NO.	SIZE	QTY/CTN
CCP21701	7"/180mm	120



ITEM NO.	SIZE	QTY/CTN
CCP21702	7"/180mm	120



ITEM NO.	SIZE	QTY/CTN
CCP21703	7"/180mm	120



ITEM NO.	SIZE	QTY/CTN
CCP21704	7"/180mm	120



ITEM NO.	SIZE	QTY/CTN
HPP23250	10"/250mm	48



ITEM NO.	SIZE	QTY/CTN
HPP24250	10"/250mm	48



ITEM NO.	SIZE	QTY/CTN
HPP26250	10"/250mm	48



ITEM NO.	SIZE	QTY/CTN
HPP25250	10"/250mm	48



ITEM NO.	SIZE	QTY/CTN
WSP0701	7"/180mm	120



ITEM NO.	SIZE	QTY/CTN
WSP0702	7"/180mm	120



ITEM NO.	SIZE	QTY/CTN
WSP0703	178mm	48



ITEM NO.	SIZE	QTY/CTN
WSP0704	178mm	48



ITEM NO.	SIZE	QTY/CTN
WSP0705	7.5"/190mm	120



ITEM NO.	SIZE	QTY/CTN
WSP1001	10"/250mm	56



ITEM NO.	SIZE	QTY/CTN
WSP1002		60



ITEM NO.	SIZE	QTY/CTN
WSP1003	7"/180mm	72



ITEM NO.	SIZE	QTY/CTN
WSP1004	7"/180mm	72



ITEM NO.	SIZE	QTY/CTN
TSP1408	8"	48
TSP1410	10"	36
TSP1412	12"	24



ITEM NO.	SIZE	QTY/CTN
TSP1508	8"	48
TSP1510	10"	36
TSP1512	12"	24



ITEM NO.	SIZE	QTY/CTN
CCT1606	6"	60
CCT1608	8"	60
CCT1610	10"	48

+ HEAVY DUTY CABLE CUTTER



ITEM NO.	SIZE	QTY/CTN
CCT1710	10"	48

+ PVC PIPE CUTTER



ITEM NO.	SIZE	QTY/CTN
PCT3501	42mm	72

+ PVC PIPE CUTTER



ITEM NO.	SIZE	QTY/CTN
PCT3502	42mm	50

+ REVOLVING PUNCH PLIERS



ITEM NO.	SIZE	QTY/CTN
RPP08020	2.5	48
	3/3.5	
	4/4.5	
	5mm	

+ GARDEN SHEARS



ITEM NO.	SIZE	QTY/CTN
GDS3608	8"/200mm	80
GDS3685	8.5"/215mm	60
GDS3610	10"/250mm	60

+ GARDEN SHEARS



ITEM NO.	SIZE	QTY/CTN
GDS3708	8"/200mm	60

+ GARDEN SHEARS



ITEM NO.	SIZE	QTY/CTN
GDS3808	8"/200mm	60
GDS3810	10"/250mm	60

+ DRAINAGE PLIERS



ITEM NO.	SIZE	QTY/CTN
HDP21709	6"/160mm	100

+ AVIATION SNIP-AMERICAN TYPE



ITEM NO.	SIZE	QTY/CTN
ASP1410L	10"/250mm	48

+ AVIATION SNIP-AMERICAN TYPE



ITEM NO.	SIZE	QTY/CTN
ASP1410S	10"/250mm	48

+ AVIATION SNIP-AMERICAN TYPE



ITEM NO.	SIZE	QTY/CTN
ASP1410R	10"/250mm	48

+ AVIATION SNIP-TAIWAN TYPE



ITEM NO.	SIZE	QTY/CTN
ASP1310S	10"/250mm	48

+ HEDGE SHEARS



ITEM NO.	SIZE	QTY/CTN
HDS6001	24"/600mm	12

+ BOLT CUTTER



ITEM NO.	SIZE	QTY/CTN
BCT2912	12"/300mm	30
BCT2914	14"/350mm	30
BCT2918	18"/450mm	20
BCT2924	24"/600mm	10
BCT2930	30"/750mm	5
BCT2936	36"/900mm	5
BCT2942	42"/105mm	4
BCT2948	48"/120mm	2

+ PIPE WRENCH



ITEM NO.	SIZE	QTY/CTN
HPW0808	8"/200mm	60
HPW0810	10"/250mm	48
HPW0812	12"/300mm	36
HPW0814	14"/350mm	24
HPW0818	18"/450mm	16
HPW0824	24"/600mm	12
HPW0836	36"/900mm	6
HPW0848	48"/122mm	4

+ 90°BENT PIPE WRENCH



ITEM NO.	SIZE	QTY/CTN
HPW0910	1"	36
HPW0915	1.5"	24
HPW0920	2"	12

+ 45°BENT PIPE WRENCH



ITEM NO.	SIZE	QTY/CTN
HPW1010	1"	36
HPW1015	1.5"	24
HPW1020	2"	12

+ 2PCS UNIVERSAL WRENCH SET



ITEM NO.	SIZE	QTY/CTN
UWS001	9-32mm	30

+ 2PCS UNIVERSAL WRENCH SET



ITEM NO.	SIZE	QTY/CTN
UWS002	9-32mm	30

+ WRECKING BAR



ITEM NO.	SIZE	QTY/CTN
WKB8018	18"	24
WKB8024	24"	12
WKB8030	30"	12
WKB8036	36"	12

ADJUSTABLE WRENCH



ITEM NO.	SIZE	QTY/CTN
ADW14200	8"/200mm	60
ADW14250	10"/250mm	48
ADW14300	12"/300mm	36

ADJUSTABLE WRENCH



ITEM NO.	SIZE	QTY/CTN
ADW15200	8"/200mm	60
ADW15250	10"/250mm	48
ADW15300	12"/300mm	36

ADJUSTABLE WRENCH



ITEM NO.	SIZE	QTY/CTN
ADW16200	8"/200mm	60
ADW16250	10"/250mm	48
ADW16300	12"/300mm	36

ADJUSTABLE WRENCH



ITEM NO.	SIZE	QTY/CTN
ADW17200	8"/200mm	60
ADW17250	10"/250mm	48
ADW17300	12"/300mm	36

9PCS FLAT HEX KEY SET



ITEM NO.	SIZE	QTY/CTN
HKF2009S	S	72
HKF2009M	M	60
HKF2009L	L	60

9PCS BALL HEX KEY SET



ITEM NO.	SIZE	QTY/CTN
HKB2009S	S	72
HKB2009M	M	60
HKB2009L	L	60

9PCS TORX HEX KEY SET



ITEM NO.	SIZE	QTY/CTN
HKS2009S	S	72
HKS2009M	M	60
HKS2009L	L	60

8PCS FOLDABLE TORX KEY SET



ITEM NO.	SIZE	QTY/CTN
HKS2008	T9-T40	60

RATCHET WRENCH



ITEM NO.	SIZE	QTY/CTN
RTW2014	1/4	24
RTW2038	3/8	36
RTW2012	1/2	100

RATCHET WRENCH



ITEM NO.	SIZE	QTY/CTN
RTW2114	1/4	24
RTW2138	3/8	36
RTW2112	1/2	100

TIRE WRENCH SET



ITEM NO.	SIZE	QTY/CTN
TWS1921	19mm/21mm	36

SPARK PLUG WRENCH



ITEM NO.	SIZE	QTY/CTN
SPW1014	14mm	50
SPW1016	16mm	50
SPW1021	21mm	50

L-HANDLE



ITEM NO.	SIZE	QTY/CTN
LHD2210	10"	48
LHD2212	12"	36

1/2 EXTENSION BAR



ITEM NO.	SIZE	QTY/CTN
EB2305	5"	100
EB2310	10"	50

SLIDE BAR



ITEM NO.	SIZE	QTY/CTN
HSB2610	10"	50
HSB2612	12"	50

SOCKET SET



ITEM NO.	SIZE	QTY/CTN
SKS2730	3pcs	24

L-TYPE WRENCH



ITEM NO.	SIZE	QTY/CTN
LTW2717	17"	50
LTW2719	19"	50
LTW2721	21"	50

L-TYPE WRENCH



ITEM NO.	SIZE	QTY/CTN
LTW1510	10mm	200
LTW1512	12mm	140
LTW1513	13mm	100
LTW1514	14mm	100
LTW1517	17mm	72
LTW1518	18mm	48
LTW1519	19mm	48
LTW1521	21mm	48

L-TYPE WRENCH WITH HOLE



ITEM NO.	SIZE	QTY/CTN
LTW1410	10mm	200
LTW1412	12mm	140
LTW1413	13mm	100
LTW1414	14mm	100
LTW1417	17mm	72
LTW1418	18mm	48
LTW1419	19mm	48
LTW1421	21mm	48

L-TYPE WRENCH WITH HOLE SET



ITEM NO.	SIZE	QTY/CTN
LWHS06	6pcs	10
LWHS07	7pcs	10

+ COMBINATION SPANNER



ITEM NO.	SIZE	QTY/CTN
CSP1108	8mm	600
CSP1110	10mm	480
CSP1112	12mm	320
CSP1113	13mm	320
CSP1117	17mm	180
CSP1119	19mm	120
CSP1120	20mm	90
CSP1122	22mm	90
CSP1124	24mm	60
CSP1127	27mm	50
CSP1130	30mm	40
CSP1132	32mm	40

+ DOUBLE OPEN END SPANNER



ITEM NO.	SIZE	QTY/CTN
DSP0607	6x7mm	480
DSP0809	8x9mm	400
DSP1011	10x11mm	400
DSP1213	12x13mm	320
DSP1415	14x15mm	240
DSP1617	16x17mm	180
DSP1819	18x19mm	160
DSP2022	20x22mm	120
DSP2123	21x23mm	90
DSP2427	24x27mm	80

+ OFFSET RING SPANNER



ITEM NO.	SIZE	QTY/CTN
ORSP0607	6x7mm	480
ORSP0809	8x9mm	400
ORSP1011	10x11mm	400
ORSP1213	12x13mm	320
ORSP1415	14x15mm	240
ORSP1617	16x17mm	180
ORSP1819	18x19mm	160
ORSP2022	20x22mm	120
ORSP2123	21x23mm	90
ORSP2427	24x27mm	80
ORSP2528	25x28mm	60
ORSP3032	30x32mm	60

+ RETCHET SPANNER



ITEM NO.	SIZE	QTY/CTN
RSP1208	8mm	300
RSP1210	10mm	300
RSP1212	12mm	240
RSP1213	13mm	240
RSP1217	17mm	144
RSP1219	19mm	120
RSP1222	22mm	72
RSP1224	24mm	36
RSP1227	27mm	36
RSP1230	30mm	32
RSP1232	32mm	32

+ RETCHET SPANNER



ITEM NO.	SIZE	QTY/CTN
RSP1308	8mm	300
RSP1310	10mm	300
RSP1312	12mm	240
RSP1313	13mm	240
RSP1317	17mm	144
RSP1319	19mm	120
RSP1322	22mm	72
RSP1324	24mm	36
RSP1327	27mm	36
RSP1330	30mm	32
RSP1332	32mm	32

+ 1/2" SOCKET



ITEM NO.	SIZE	QTY/CTN
SKT2709	9mm	200
SKT2710	10mm	200
SKT2711	11mm	200
SKT2712	12mm	200
SKT2713	13mm	200
SKT2714	14mm	200
SKT2715	15mm	200
SKT2717	17mm	100
SKT2718	18mm	80
SKT2719	19mm	80
SKT2720	20mm	80
SKT2721	21mm	80

+ 1/2" DEEP SOCKET



ITEM NO.	SIZE	QTY/CTN
SKT2709D	9mm	100
SKT2710D	10mm	100
SKT2711D	11mm	100
SKT2712D	12mm	100
SKT2713D	13mm	100
SKT2714D	14mm	100
SKT2715D	15mm	100
SKT2717D	17mm	60
SKT2718D	18mm	60
SKT2719D	19mm	60
SKT2720D	20mm	60
SKT2721D	21mm	60

+ T-HANDLE SOCKET WRENCH



ITEM NO.	SIZE	QTY/CTN
TSW2508	8mm	100
TSW2509	9mm	100
TSW2510	10mm	100
TSW2511	11mm	100
TSW2512	12mm	100
TSW2513	13mm	100
TSW2514	14mm	100
TSW2515	15mm	80
TSW2517	17mm	80
TSW2518	18mm	80
TSW2519	19mm	80

+ Y-TYPE SOCKET WRENCH



ITEM NO.	SIZE	QTY/CTN
YSW080910	8x9x10	100
YSW081012	8x10x12	100
YSW101214	10x12x14	100
YSW121417	12x14x17	80
YSW141719	14x17x19	80

+ CROSS RIM WRENCH 14"



ITEM NO.	SIZE	QTY/CTN
CRW1401	17-19-21-23mm	12

+ CROSS RIM WRENCH 14"



ITEM NO.	SIZE	QTY/CTN
CRW1403	17-19-21-23mm	12

+ CROSS RIM WRENCH 15"



ITEM NO.	SIZE	QTY/CTN
CRW1502	17-19-21-23mm	12

+ T-HANDLE SOCKET



ITEM NO.	SIZE	QTY/CTN
TST2608	8mm	100

+ 1/2" SOCKET SET



ITEM NO.	SIZE	QTY/CTN
SKT5024	24pcs	5

+ 12PCS 1/2" SOCKET SET



ITEM NO.	SIZE	QTY/CTN
SKTS012	9/10/11/12/13 14/15/17/19/21mm	20

+ 8PCS COMBINATION SPANNER SET



ITEM NO.	SIZE	QTY/CTN
CSS11080	6, 8, 10, 12 14, 15, 17, 19mm	10

+ CYLINDER BRUSH



ITEM NO.	SIZE	QTY/CTN
CBS4209	9"	50

+ CYLINDER BRUSH



ITEM NO.	SIZE	QTY/CTN
CBS4309	9"	50

+ PAINT BRUSH WOODEN HANDLE



ITEM NO.	SIZE	QTY/CTN
PBS6210W	1"	600
PBS6215W	1.5"	480
PBS6220W	2"	240
PBS6225W	2.5"	240
PBS6230W	3"	240
PBS6240W	4"	120

+ PAINT BRUSH PLASTIC HANDLE



ITEM NO.	SIZE	QTY/CTN
PBS6310	1"	600
PBS6315	1.5"	480
PBS6320	2"	240
PBS6325	2.5"	240
PBS6330	3"	240
PBS6340	4"	120

MACHINIST HAMMER
TPR HANDLE



ITEM NO.	SIZE	QTY/CTN
MHM20300	300g	48
MHM20500	500g	36
MHM21000	1000g	24

CLAW HAMMER
TPR HANDLE



ITEM NO.	SIZE	QTY/CTN
CHM2208	8oz	48
CHM2216	16oz	36

BALLPEIN HAMMER
TPR HANDLE



ITEM NO.	SIZE	QTY/CTN
BHM2412	12oz	60
BHM2424	24oz	36
BHM2432	32oz	24

STONING HAMMER
TPR HANDLE



ITEM NO.	SIZE	QTY/CTN
SHM61000	1000g	24
SHM61500	1500g	12
SHM62000	2000g	12

SLEDGE HAMMER
TPR HANDLE



ITEM NO.	SIZE	QTY/CTN
LHM6020	2lb	24
LHM6030	3lb	12
LHM6040	4lb	12

RUBBER HAMMER
TPR HANDLE



ITEM NO.	SIZE	QTY/CTN
RHM1008	8oz	48
RHM1012	12oz	36
RHM1016	16oz	36
RHM1024	24oz	24

RUBBER HAMMER
TPR HANDLE



ITEM NO.	SIZE	QTY/CTN
RHM1208	8oz	48
RHM1212	12oz	36
RHM1216	16oz	36
RHM1224	24oz	24

AXE
TPR HANDLE



ITEM NO.	SIZE	QTY/CTN
HAX7600	600g	36

COLD CHISEL



ITEM NO.	SIZE	QTY/CTN
CDC7300P	25x300mm	36
CDC7300F	25x300mm	36

WOOD CHISEL
WOOD HANDLE



ITEM NO.	SIZE	QTY/CTN
WCH5208	8mm	72
WCH5212	12mm	72
WCH5216	16mm	72
WCH5219	19mm	72
WCH5222	22mm	72
WCH5225	25mm	72

WOOD CHISEL
TPR HANDLE



ITEM NO.	SIZE	QTY/CTN
WCH5308	8mm	72
WCH5312	12mm	72
WCH5316	16mm	72
WCH5319	19mm	72
WCH5322	22mm	72
WCH5325	25mm	72

4 PCS WOOD CHISEL
TPR HANDLE



ITEM NO.	SIZE	QTY/CTN
WCS5404	6mm	30
	12mm	
	19mm	
	25mm	

FLAT STEEL FILE



ITEM NO.	SIZE	QTY/CTN
STF3008F	8" Flat	72

HALF ROUND STEEL FILE



ITEM NO.	SIZE	QTY/CTN
STF3008HR	8" Half Round	72

ROUND STEEL FILE



ITEM NO.	SIZE	QTY/CTN
STF3008R	8" Round	72

TRIANGLE STEEL FILE



ITEM NO.	SIZE	QTY/CTN
STF3008T	8" Triangle	72

SQUARE STEEL FILE



ITEM NO.	SIZE	QTY/CTN
STF3008S	8" Square	72

FLAT WOOD FILE



ITEM NO.	SIZE	QTY/CTN
WDF3108F	8" Flat	72

HALF ROUND WOOD FILE



ITEM NO.	SIZE	QTY/CTN
WDF3108HR	8" Half Round	72

3 PCS STEEL FILE SET



ITEM NO.	SIZE	QTY/CTN
STFS003	flat steel round steel half round steel	20

+ HACKSAW FRAME



ITEM NO.	SIZE	QTY/CTN
HKF5301	12"	48

+ ADJUSTABLE HACKSAW FRAME



ITEM NO.	SIZE	QTY/CTN
HKF5302A	12"	48

+ ADJUSTABLE HACKSAW FRAME



ITEM NO.	SIZE	QTY/CTN
HKF5302B	12"	48

+ HACKSAW FRAME



ITEM NO.	SIZE	QTY/CTN
HKF5304	12"	48

+ HACKSAW FRAME



ITEM NO.	SIZE	QTY/CTN
HKF5305	12"	48

+ HACKSAW FRAME



ITEM NO.	SIZE	QTY/CTN
HKF5306	12"	48

+ HACKSAW FRAME



ITEM NO.	SIZE	QTY/CTN
HKF5307	12"	48

+ BI-METAL HACKSAW BLADE



ITEM NO.	SIZE	QTY/CTN
HSB53001	12"	500

+ HAND SAW



ITEM NO.	SIZE	QTY/CTN
HDS55016	16"	48
HDS55018	18"	48
HDS55020	20"	48
HDS55022	22"	48

+ COMPAS SAW



ITEM NO.	SIZE	QTY/CTN
CPS57012	12"	60

+ GYPSUM BOARD PLANING



ITEM NO.	SIZE	QTY/CTN
GBP10140	140mm	144
GBP10250	250mm	72

+ GYPSUM BOARD PLANING



ITEM NO.	SIZE	QTY/CTN
GBP11140	140mm	30
GBP11250	250mm	30

+ CAULKING GUN



ITEM NO.	SIZE	QTY/CTN
CKG8001	9"	36

+ CAULKING GUN



ITEM NO.	SIZE	QTY/CTN
CKG8002	9"	36

+ CAULKING GUN



ITEM NO.	SIZE	QTY/CTN
CKG8003	9"	36

+ CAULKING GUN



ITEM NO.	SIZE	QTY/CTN
CKG8004	9"	36

+ ALUMINUM CAULKING GUN



ITEM NO.	SIZE	QTY/CTN
CKG8109	9"	24
CKG8112	12"	24
CKG8115	15"	24

+ GREASE GUN



ITEM NO.	SIZE	QTY/CTN
GSG6001	600cc	20
GSG6002	600cc	20

+ GREASE GUN



ITEM NO.	SIZE	QTY/CTN
GSG6002	600cc	20

+ PUTTY TROWEL



ITEM NO.	SIZE	QTY/CTN
PTW1025	2.5"	120
PTW1030	3"	120
PTW1040	4"	120
PTW1060	6"	120

+ BRICKLAYING TROWEL



ITEM NO.	SIZE	QTY/CTN
BTW1106W	6"	120
BTW1107W	7"	120
BTW1108W	8"	120
BTW1109W	9"	120

+ BRICKLAYING TROWEL



ITEM NO.	SIZE	QTY/CTN
BTW1206	6"	72
BTW1207	7"	72
BTW1208	8"	72
BTW1209	9"	72

+ PLASTERING TROWEL



ITEM NO.	SIZE	QTY/CTN
PTT2813	280*130	60

+ PLASTERING TROWEL



ITEM NO.	SIZE	QTY/CTN
PTT2813T	280*130	60

+ HAND RIVETER



ITEM NO.	SIZE	QTY/CTN
HRT5101	10"	40

+ HAND RIVETER



ITEM NO.	SIZE	QTY/CTN
HRT5102	10.5"	40

+ FOLDING HAND RIVETER



ITEM NO.	SIZE	QTY/CTN
HRT5103	32"	12

+ HAND RIVETER



ITEM NO.	SIZE	QTY/CTN
HRT5104	17"/430mm φ2.4/3.2/4.0/4.8	20

+ HAND RIVETER



ITEM NO.	SIZE	QTY/CTN
HRT5105	13"/330mm φ3.2/4.0/4.8	20

+ STAPLE GUN



ITEM NO.	SIZE	QTY/CTN
STG5201	4-14mm	24

+ STAPLE GUN



ITEM NO.	SIZE	QTY/CTN
STG5202	4-14mm	24

+ STAPLE GUN



ITEM NO.	SIZE	QTY/CTN
STG5203	4-14mm	24

+ DIGITAL CLAMP METER



ITEM NO.	DCM6626
Voltage DC	1000V
Voltage AC	750V
Current AC	20/200/1000A
Resistance	2kΩ/200kΩ
Diode Check	about 3.0V/1mA
Power Source	9V battery(6F22)

+ DIGITAL MULTIMETER



ITEM NO.	DMT6801
Voltage DC	200mV/2V/20V/200V/1000V
Voltage AC	200mV/2V/20V/200V/750V
Current DC	2μA/20μA/200μA/2mA/20mA/200mA/10A
Resistance	200Ω/2kΩ/20kΩ/200kΩ/2MΩ
Diode Check	about 2.8V/1mA
Power Source	9V battery(6F22)

+ DIGITAL MULTIMETER



ITEM NO.	DMT6803
Voltage DC	200mV/2V/20V/200V/1000V
Voltage AC	200mV/2V/20V/200V/750V
Current DC	2μA/20μA/200μA/2mA/20mA/200mA/20A
Resistance	200Ω/2kΩ/20kΩ/200kΩ/2MΩ/20MΩ/200MΩ

+ DIGITAL VOLTAGE TESTER



ITEM NO.	DVT6105
AC Voltage	900V-1000V
Frequency	50/60HZ
Low Battery Indication	≤2.0V
Power Supply	2*1.5V AAA battery

+ VOLTAGE TESTER



ITEM NO.	QTY/CTN
DVT6106	600

+ VOLTAGE TESTER



ITEM NO.	QTY/CTN
DVT6108	600

+ GLUE GUN 20W



ITEM NO.	SIZE	QTY/CTN
GLG5020	20W	60

+ GLUE GUN 40W



ITEM NO.	SIZE	QTY/CTN
GLG5040	40W	48

+ G CLAMP



ITEM NO.	SIZE	QTY/CTN
GLP3104	4"	32
GLP3105	5"	32
GLP3106	6"	24

+ PLASTIC CLAMP



ITEM NO.	SIZE	QTY/CTN
PCP3210	10"	24
PCP3212	12"	24
PCP3218	18"	24
PCP3224	24"	12
PCP3230	30"	12

+ F CLAMP



ITEM NO.	SIZE	QTY/CTN
FCP50200	50x200mm	50
FCP80300	80x300mm	20
FCP120300	120x300mm	12
FCP120500	120x500mm	12
FCP120800	120x800mm	12

+ ELECTRICIAN KNIFE



ITEM NO.	SIZE	QTY/CTN
EFK63185	7"	100
EFK63185S	7"	100

+ MEASURE TAPE



ITEM NO.	SIZE	QTY/CTN
MTP41316	3M*16mm	144
MTP41519	5M*19mm	108
MTP41725	7.5M*25mm	72

+ MEASURE TAPE



ITEM NO.	SIZE	QTY/CTN
MTP42316	3M*16mm	144
MTP42519	5M*19mm	108
MTP42725	7.5M*25mm	72

+ MEASURE TAPE



ITEM NO.	SIZE	QTY/CTN
MTP43316	3M*16mm	144
MTP43519	5M*19mm	108
MTP43725	7.5M*25mm	72

+ MEASURE TAPE SELF-LOCKING



ITEM NO.	SIZE	QTY/CTN
MTP44316	3M*16mm	144
MTP44519	5M*19mm	108
MTP44725	7.5M*25mm	72

+ LONG STEEL MEASURE TAPE



ITEM NO.	SIZE	QTY/CTN
SMTP47030	30M	20
SMTP47050	50M	20
SMTP47100	100M	20

+ LONG FIBERGLASS MEASURE TAPE



ITEM NO.	SIZE	QTY/CTN
FMT48010	10M	60
FMT48020	20M	60
FMT48030	30M	60
FMT48050	50M	30

+ SPIRIT LEVEL



ITEM NO.	SIZE	QTY/CTN
SPL6030	12"/30cm	60
SPL6040	16"/40cm	60
SPL6060	24"/60cm	60
SPL6080	32"/80cm	30
SPL60100	40"/100cm	30

+ HEAVY DUTY SPIRIT LEVEL



ITEM NO.	SIZE	QTY/CTN
SPL7030	12"/30cm	60
SPL7040	16"/40cm	60
SPL7060	24"/60cm	60
SPL7080	32"/80cm	30
SPL70100	40"/100cm	30

+ BRIDGE SPIRIT LEVEL



ITEM NO.	SIZE	QTY/CTN
SPL8030	12"/30cm	60
SPL8040	16"/40cm	60
SPL8060	24"/60cm	60
SPL8080	32"/80cm	30
SPL80100	40"/100cm	30

+ ALUMINUM SQUARE RULER



ITEM NO.	SIZE	QTY/CTN
ALR6125	25cm	60
ALR6130	30cm	60
ALR6140	40cm	60

+ ANGLE RULER



ITEM NO.	SIZE	QTY/CTN
ALR7130	30CM	60

+ SQUARE RULER



ITEM NO.	SIZE	QTY/CTN
SRL5030	30CM	60

+ UTILITY KNIFE



ITEM NO.	SIZE	QTY/CTN
UKN1803	3 BLADES	144

+ UTILITY KNIFE



ITEM NO.	SIZE	QTY/CTN
UKN1804	19mm	144

+ FOLDABLE KNIFE



ITEM NO.	SIZE	QTY/CTN
FKF6319	19mm	144

+ 10PCS KNIFE BLADE CK75



ITEM NO.	SIZE	QTY/CTN
KNB1901	18x100mm	240

+ SCREWDRIVER PHILLIPS



ITEM NO.	SIZE	QTY/CTN
SDR05100PH	SL4.0X100	120
SDR05125PH	SL5.5X125	120
SDR05160PH	SL6.5X150	120

+ SCREWDRIVER SLOTTED



ITEM NO.	SIZE	QTY/CTN
SDR05100	SL4.0X100	120
SDR05125	SL5.5X125	120
SDR05160	SL6.5X150	120

+ INSULATION SCREWDRIVER



ITEM NO.	SIZE	QTY/CTN
ISD40100	SL4.0X100	72
ISD55125	SL5.5X125	72
ISD65150	SL6.5X150	72

+ INSULATION SCREWDRIVER



ITEM NO.	SIZE	QTY/CTN
ISD0072	PH0X100	72
ISD0180	PH1X125	72
ISD02100	PH2X150	72

+ 9 PCS SCREWDRIVER SET



ITEM NO.	QTY/CTN
SDRS009	48

+ PLASTIC TOOL BOX



ITEM NO.	SIZE	QTY/CTN
PTB7313	13"/330x175x155mm	16
PTB7315	15"/385x215x195mm	12
PTB7318	18"/440x260x230mm	9
PTB7321	21"/530x305x255mm	6

+ TOOL BOX



ITEM NO.	SIZE	QTY/CTN
TTB7117	17"	4
TTB7121	21"	4

+ SAFETY GOGGLE



ITEM NO.	QTY/CTN
SFG1001	200

+ SAFETY BOOTS WITH STEEL



ITEM NO.	SIZE	QTY/CTN
SFB0340S	40#	10
SFB0341S	41#	10
SFB0342S	42#	10
SFB0343S	43#	10
SFB0344S	44#	10

+ SAFETY BOOTS



ITEM NO.	SIZE	QTY/CTN
SFB0340	40#	10
SFB0341	41#	10
SFB0342	42#	10
SFB0343	43#	10
SFB0344	44#	10

+ SAFETY HELMET



ITEM NO.	QTY/CTN
SFH2001	40

+ WELDING MASK



ITEM NO.	QTY/CTN
WDM2002	24

+ SDS-PLUS CHISEL



ITEM NO.	SIZE	QTY/CTN
SPC14250P	14x250mm	50
SPC14250F	14x20x250mm	50

+ HEX CHISEL



ITEM NO.	SIZE	QTY/CTN
HCL30410P	17x280mm	50
HCL30410F	17x22x280mm	50

+ HEX CHISEL



ITEM NO.	SIZE	QTY/CTN
HCL31410P	17x280mm	50
HCL31410F	17x22x280mm	50

+ SDS-MAX CHISEL



ITEM NO.	SIZE	QTY/CTN
SPC15250P	18x300mm	20
SPC15250F	18x25x300mm	20

+ PH65 CHISEL



ITEM NO.	SIZE	QTY/CTN
PHC30410P	30x410mm	10
PHC30410F	30x35x410mm	10

+ DIAMOND CORE DRILL BIT



ITEM NO.	SIZE	QTY/CTN
DBD02400	Φ2"x400mm	20
DBD03400	Φ3"x400mm	9
DBD04400	Φ4"x400mm	6
DBD05400	Φ5"x400mm	4
DBD06400	Φ6"x400mm	4
DBD08400	Φ8"x400mm	2

+ GLASS HOLE SAW



ITEM NO.	SIZE
HSG22026	26mm
HSG22035	35mm

+ T.C.T HOLE SAW(SDS)



ITEM NO.	SIZE
HST26050	50mm
HST26065	65mm
HST26080	80mm
HST26100	100mm

+ FORSTNER DRILL BIT



ITEM NO.	SIZE
DBFT1025	25mm
DBFT1032	32mm
DBFT1035	35mm

+ HSS HOLE SAW



ITEM NO.	SIZE
HSH27012	12mm
HSH27020	20mm
HSH27026	26mm
HSH27035	35mm

+ T.C.T HOLE SAW



ITEM NO.	SIZE
THS28019	19mm
THS28022	22mm
THS28030	30mm
THS28035	35mm

+ T.C.T HOLE SAW



ITEM NO.	SIZE
THS29019	19mm
THS29022	22mm
THS29030	30mm
THS29035	35mm

+ SDS PLUS HAMMER DRILL BITS



ITEM NO.	SIZE	QTY/CTN
SDH5110	5x110mm	200
SDH8110	6x110mm	200
SDH8110	8x110mm	200
SDH10110	10x110mm	200
SDH5160	5x160mm	200
SDH8160	6x160mm	200
SDH8160	8x160mm	200
SDH10160	10x160mm	200
SDH12160	12x160mm	200
SDH14160	14x160mm	200
SDH6210	6x210mm	200
SDH8210	8x210mm	200
SDH10210	10x210mm	200
SDH12210	12x210mm	200
SDH14210	14x210mm	100
SDH16210	16x210mm	100
SDH8260	8x260mm	200
SDH10260	10x260mm	200
SDH12260	12x260mm	100
SDH14260	14x260mm	50
SDH10350	10x350mm	100
SDH12350	12x350mm	100
SDH16350	16x350mm	50

+ M35 HSS TWIST DRILL BITS



ITEM NO.	SIZE	QTY/CTN
HTD104-3.5	3.5x70mm	80
HTD104-4.0	4.0x75mm	80
HTD104-4.5	4.5x80mm	80
HTD104-5.0	5.0x86mm	80
HTD104-5.5	5.5x93mm	80
HTD104-6.0	6.0x93mm	80
HTD104-6.5	6.5x101mm	60
HTD104-7.0	7.0x109mm	60
HTD104-7.5	7.5x109mm	60
HTD104-8.0	8.0x117mm	60
HTD104-8.5	8.5x117mm	60
HTD104-9.0	9.0x125mm	60
HTD104-9.5	9.5x125mm	60
HTD104-10.0	10.0x133mm	60
HTD104-10.5	10.5x133mm	60
HTD104-11.0	11.0x142mm	40
HTD104-11.5	11.5x142mm	40
HTD104-12.0	12.0x151mm	40
HTD104-12.5	12.5x151mm	40
HTD104-13.0	13.0x151mm	40

+ M2 HSS TWIST DRILL BITS



ITEM NO.	SIZE	QTY/CTN
HTD105-3.5	3.5x70mm	80
HTD105-4.0	4.0x75mm	80
HTD105-4.5	4.5x80mm	80
HTD105-5.0	5.0x86mm	80
HTD105-5.5	5.5x93mm	80
HTD105-6.0	6.0x93mm	80
HTD105-6.5	6.5x101mm	60
HTD105-7.0	7.0x109mm	60
HTD105-7.5	7.5x109mm	60
HTD105-8.0	8.0x117mm	60
HTD105-8.5	8.5x117mm	60
HTD105-9.0	9.0x125mm	60
HTD105-9.5	9.5x125mm	60
HTD105-10.0	10.0x133mm	60
HTD105-10.5	10.5x133mm	60
HTD105-11.0	11.0x142mm	40
HTD105-11.5	11.5x142mm	40
HTD105-12.0	12.0x151mm	40
HTD105-12.5	12.5x151mm	40
HTD105-13.0	13.0x151mm	40

+ FLAT WOOD BITS



ITEM NO.	SIZE	QTY/CTN
FTW1506	6mm	100
FTW1508	8mm	100
FTW15010	10mm	100
FTW15012	12mm	100
FTW15013	13mm	100
FTW15014	14mm	100
FTW15016	16mm	100
FTW15018	18mm	100
FTW15019	19mm	100
FTW15020	20mm	80
FTW15022	22mm	80
FTW15024	24mm	80
FTW15025	25mm	80
FTW15028	28mm	80
FTW15030	30mm	60
FTW15032	32mm	60
FTW15035	35mm	60
FTW15036	36mm	60
FTW15038	38mm	60
FTW15040	40mm	60

+ WOOD TWIST DRILL BITS



ITEM NO.	SIZE	QTY/CTN
WTD0361	3x61mm	80
WTD07109	7x109mm	60
WTD10133	10x133mm	60
WTD13151	13x151mm	40

+ AUGER DRILL BIT



ITEM NO.	SIZE	QTY/CTN
DBA08235	8x235mm	250
DBA10235	10x235mm	250
DBA12235	12x235mm	100
DBA28460	28x460mm	25
DBA30460	30x460mm	25
DBA32460	32x460mm	25

+ 5PCS MASONRY DRILL BITS SET



ITEM NO.	SIZE	QTY/CTN
MDB0805	4-5-6-8-10mm	100

+ MAGNETIC NUT SETTER



ITEM NO.	SIZE	QTY/CTN
MNS0842	8*42mm	2000
MNS1065	10*65mm	1000

+ SCREWDRIVER BIT
CRV



ITEM NO.	SIZE	QTY/CTN
SDB65065	65mm	1000

+ SCREWDRIVER BIT
SK2



ITEM NO.	SIZE	QTY/CTN
SDB66065	65mm	1000

+ SCREWDRIVER BIT
SK2



ITEM NO.	SIZE	QTY/CTN
SDB67065	65mm	1000

+ SCREWDRIVER BIT
SK2



ITEM NO.	SIZE	QTY/CTN
SDB68065	65mm	1000

DIAMOND DISC DRY CUTTING



ITEM NO.	SIZE	QTY/CTN
DMB07100	100x7x16mm	100
DMB07115	115x7x22.23mm	100
DMB07125	125x7x22.23mm	100

DIAMOND DISC WET CUTTING



ITEM NO.	SIZE	QTY/CTN
DMB08100	100x7x16mm	100
DMB08115	115x7x22.23mm	100
DMB08125	125x7x22.23mm	100

DIAMOND DISC DRY & WET CUTTING



ITEM NO.	SIZE	QTY/CTN
DMB09100	100x7x16mm	100
DMB09115	115x7x22.23mm	100
DMB09125	125x7x22.23mm	100

DIAMOND CUP WHEEL



ITEM NO.	SIZE	QTY/CTN
DCW22115	115mm	50
DCW22125	125mm	50

DIAMOND CUP WHEEL



ITEM NO.	SIZE	QTY/CTN
DCW23115	115mm	50
DCW23125	125mm	50

T.C.T SAW BLADE WOOD CUTTING



ITEM NO.	SIZE	QTY/CTN
TSB11530	115x30T	100
TSB11540T	115x40T	100
TSB18540	185x40T	50
TSB18560	185x60T	50
TSB23040	230x40T	25
TSB23060	230x60T	25

T.C.T SAW BLADE ALUMINIUM CUTTING



ITEM NO.	SIZE	QTY/CTN
TSB25480	254x80T	20
TSB254100	254x100T	20

RECIPROCATING SAW BLADE



ITEM NO.	SIZE	QTY/CTN
RSBS010	6"X6TPI	50
	6"X10TPI	
	6"X18TPI	
	8"X6TPI	

WIRE CUP BRUSHES CRIMPED



ITEM NO.	SIZE	THREAD SIZE	QTY/CTN
WCC12075	3"/75mm	M10x2	100
WCC12100	4"/100mm	M10x1.5	60
WCC12125	5"/125mm	M14x2	24
WCC12150	6"/150mm	M14x2	24

WIRE CUP BRUSHES TWISTED



ITEM NO.	SIZE	THREAD SIZE	QTY/CTN
WCT13075	3"/75mm	M10x2	100
WCT13100	4"/100mm	M10x1.5	60
WCT13125	5"/125mm	M14x2	24
WCT13150	6"/150mm	M14x2	24

WIRE CUP BRUSHES CRIMPED WITH SHANK



ITEM NO.	SIZE
WCCS13050	2"/50mmx6.35
WCCS13075	3"/75mmx6.35
WCCS13100	4"/100mmx6.35

WIRE CUP BRUSHES TWISTED WITH SHANK



ITEM NO.	SIZE
WCTS13050	2"/50mmx6.35
WCTS13075	3"/75mmx6.35
WCTS13100	4"/100mmx6.35

WIRE WHEEL



ITEM NO.	SIZE
WWL15125	5"/125mmx22.0
WWL15150	6"/150mmx22.0
WWL15180	7"/180mmx25.4
WWL15200	8"/200mmx25.4

WIRE WHEEL



ITEM NO.	SIZE
WWL16125	5"/125mmx22.0
WWL16150	6"/150mmx22.0
WWL16180	7"/180mmx25.4
WWL16200	8"/200mmx25.4

WIRE WHEEL FOR BENCH GRINDERS



ITEM NO.	SIZE
WWG17125	5"/125mmx22.0
WWG17150	6"/150mmx22.0
WWG17180	7"/180mmx25.4
WWG17200	8"/200mmx25.4

WIRE WHEEL FOR BENCH GRINDERS



ITEM NO.	SIZE
WWG18125	5"/125mmx22.0
WWG18150	6"/150mmx22.0
WWG18180	7"/180mmx25.4
WWG18200	8"/200mmx25.4

ABRASIVE CUTTING DISC



ITEM NO.	SIZE	QTY/CTN
CTD10012	100x1.2x16mm	400
CTD11512	115x1.2x22mm	400
CTD11530	115x3x22mm	200
CTD12530	125x3x22mm	200
CTD18030	180x3x22mm	100
CTD35530	355x3x25.4mm	25

ABRASIVE CUTTING DISC



ITEM NO.	SIZE	QTY/CTN
CGD10006	100x6x16mm	200
CGD11506	115x6x22mm	100
CGD12506	125x6x22mm	100
CGD15006	150x6x22mm	50
CGD18006	180x6x22mm	50
CGD23006	230x6x22mm	25

FLAP DISC



ITEM NO.	SIZE	QTY/CTN
FPD80115	115xP80	200
FPD80125	125xP80	200

POLISHING PAD



ITEM NO.	SIZE
PSP14115	115xM14
PSP14180	180xM14

