

## ☑ Dimensions in mm

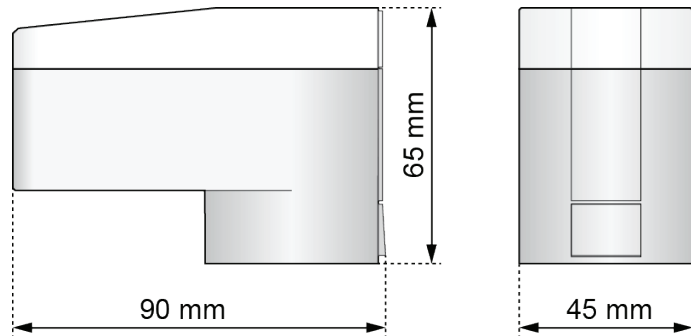

## ☑ Models

- 1 **7708 40** **HERZ Motor Valve Drive, 3-point, M28 x 1.5, 24 V, 50 Hz**  
normally closed, actuating force 200 N, operating voltage 24 V AC/DC, threaded connection M28 x 1.5, blue adapter 1 **7708 85** is included, max. stroke 8,5 mm
- 1 **7708 41** **HERZ Motor Valve Drive, 3-point, M28 x 1.5, 230 V, 50 Hz**  
normally closed, actuating force 200 N, operating voltage 230 V ~, threaded connection M28 x 1.5, blue adapter 1 **7708 85** is included, max. stroke 8,5 mm
- 1 **7708 42** **HERZ Motor Valve Drive, modulating 0..10 V, M28 x 1.5, 24 V, 50 Hz**  
normally closed, actuating force 200 N, operating voltage 24 V AC/DC, threaded connection M28 x 1.5, blue adapter 1 **7708 85** is included, max. stroke 8,5 mm with stroke recognition.
- 1 **7708 46** **HERZ Motor Valve Drive, modulating 0..10 V, M28 x 1.5, 24 V, 50 Hz**  
normally closed, actuating force 200 N, operating voltage 24 V AC/DC, threaded connection M28 x 1.5, blue adapter 1 **7708 85** is included, max. stroke 8,5 mm with stroke recognition and feedback signal
- 5 **7712 08** **HERZ Motor Valve Drive, modulating 0..10 V, M28 x 1.5, 24 V, 50 Hz**  
normally closed, actuating force 125 N, operating voltage 24 V AC/DC, threaded connection M28 x 1.5, blue adapter 1 **7708 85** is included, max. stroke 8,5 mm with stroke recognition.  
Equal percentage characteristic.
- 5 **7712 46** **HERZ Motor Valve Drive, modulating 0..10 V, M28 x 1.5, 24 V, 50 Hz**  
normally closed, actuating force 125 N, operating voltage 24 V AC/DC, threaded connection M28 x 1.5, blue adapter 1 **7708 85** is included, max. stroke 8,5 mm with stroke recognition and feedback signal. Equal percentage characteristic. (Option with failsafe: 5 7712 48)

## ☑ Description 1 7708 40

The HERZ Motor Valve Drive 1 **7708 40** is an electromotive actuator for valves used in heating and cooling systems. The HERZ Motor Valve Drive 1 **7708 40** is controlled via a corresponding room thermostat. The actuator is equipped with a plug-in connection line, a LED for function display as well as with a manual stroke setting which can be used e. g. for maintenance or for mounting purposes. The predominant area of application is the energy-efficient control of water-bearing valves in the area of building services and automation.

## ☑ Description 1 7708 41

The HERZ Motor Valve Drive 1 **7708 41** is an electromotive actuator for valves used in heating and cooling systems. The HERZ Motor Valve Drive 1 **7708 41** is controlled via a corresponding room thermostat or a building management system. The actuator is equipped with a fixed connection line, a LED for function display as well as with a manual stroke setting which can be used e. g. for maintenance or for dismantling purposes. The predominant area of application is the energy-efficient control of water-bearing valves in the area of building services and automation.

## ☑ Description 1 7708 42/46, 5 7712 08/46

The HERZ Motor Valve Drives are electromotive actuators for valves used in heating and cooling systems. The control of the HERZ Motor Valve Drives are performed by a 0 - 10 V DC control signal via a central DDC system or by a room thermostat. The actuators are equipped with a LCD display with background illumination for displaying the current stroke, the control voltage, and the operating modes (open/close), as well as for the output of error codes. The actuators are equipped with a plug-in connection line as well as with a manual stroke setting, which can be used e. g. for maintenance or dismantling purposes. The predominant field of application is the energy-efficient control of water-bearing valves in the area of building services and automation.

5 **7712 08**: Equal percentage characteristic.

5 **7712 46**: Equal percentage characteristic with position feedback signal.

### ☑ Function

The actuator mechanism of the HERZ Motor Valve Drive works with a stop motor, an intelligent micro controller and a gearing mechanism. The force generated by the movement direction is transferred to the valve pressure plate, thus opening or closing the valve. The actuator is installed directly to the upper part of the small valve. The actuator is supplied with a retracted valve pressure plate.

### ☑ Operation 1 7708 40

The motor-driven actuator HERZ Motor Valve Drive 1 **7708 40** is controlled via two electric connections L1 (open) and L2 (close), realizing the desired movement direction of the motor. This moves the valve pressure plate in the desired direction for opening or closing. If the control signal L1 (open) is applied, the valve opens. The control signal L2 (close) closes the valve. After reaching the final stop resp. the closing position, the motor switches off. This also applies in case of overload. If the voltage is switched off, the valve remains in its current position.

### ☑ Operation 1 7708 41

The motor-driven actuator HERZ Motor Valve Drive 1 **7708 41** is controlled via two electric connections L1-1 (open) and L1-2 (close), realizing the desired movement direction of the motor. This moves the valve pressure plate in the desired direction for opening or closing. If the control signal L1-1 (open) is applied, the valve opens. The control signal L1-2 (close) closes the valve. After reaching the final stop resp. the closing position, the motor switches off. This also applies in case of overload. If the voltage is switched off, the valve remains in its current position.

### ☑ Operation 1 7708 42/46, 5 7712 08/46

The control of the HERZ Motor Valve Drives are performed by a 0 - 10 V DC control signal via a central DDC system or by a room thermostat. Depending on the control signal, precise positioning of the actuator will be performed with respect to the valve. At 0 V the actuator is completely closed, and at 10 V it is completely opened. The pulse width modulation is between 100 Hz and 1000 Hz.

**5 7712 08:** Equal percentage characteristic.

**5 7712 46:** Equal percentage characteristic with position feedback signal.

### ☑ Initialisation 1 7708 42 / 5 7712 08

First, the valves pressure plate is fully retracted, whereby the upper end-stop of the drive is determined. Following the valve plate extends fully and determined the bottom end stop, the closing point of the valve and this point of the valve is detected. If a control voltage is applied, the actuator opens the valve smoothly. The drive is calculating from control voltage and actuator travel, the needed position and move to it precisely.

### ☑ Initialisation 1 7708 46 / 5 7712 46

First, the valves pressure plate is fully retracted, whereby the upper end-stop of the drive is determined. Following the valve plate extends fully and determined the bottom end stop, the closing point of the valve and this point of the valve is detected. Now the valve stroke recognition will happen. Therefor the actuators moves with high speed to the upper position and back to the lower position slowly, for determining the valve stroke. In case of not sensing the valve, the actuators will work with the factory setting stroke (8.5 mm).

The stroke of the valve can be changed in practice by different conditions. The valve was adjusted, or the actuators were mounted to a new valve. In both cases, the data obtained at the initialization values has changed. Thus, the actuator adjusts to the new valve stroke, the power supply must be interrupted briefly. After the power has been switched on again, the actuator performs a new initialization phase.

### ☑ Control input

The control input allows a precise control of the HERZ Motor Valve Drives with the help of a 0 - 10 V or PWM signal. The pulse width modulation is between 100 Hz and 1000 Hz. A selection of the input signal eases the integration of the actuator into a building management system.

**Feedback signal 1 7708 46 / 5 7712 46**

The Feedback Signal of the actuators: Proportional MPO allows a direct feedback of the current operating status. Voltages of 1 to 9 volts supply information about the actuator position, voltages < 0.5 V and > 9.5 V point to possible errors. The feedback channel emits a voltage proportional to the actuator path position.

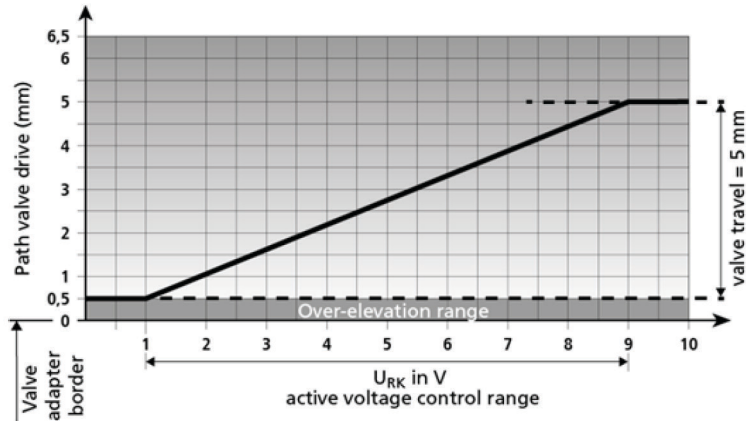

Example

Voltage Description	
< 0.5 V	No function or no contacting
1 V to 9 V	voltage emitted to the valve path is either linear or equal percentage charecterised.
1 V	corresponds to a closed valve
9 V	corresponds to an open valve
> 9.5 V	Internal error

**Charecteristic curve 5 7712 08 / 5 7712 46**

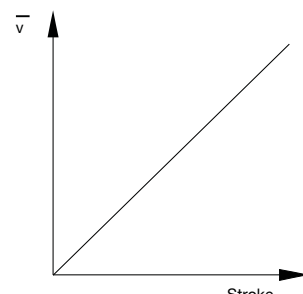
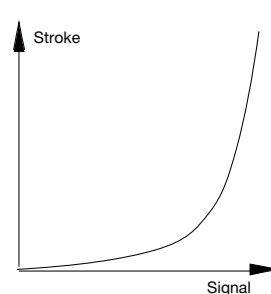
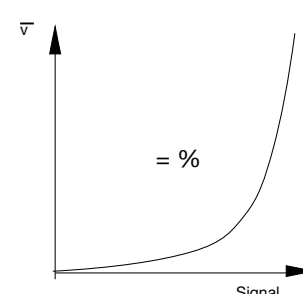
Charecteristic curve for Valve	Charecteristic curve for Drive	Effect on Valve
 <p>A graph with 'v' on the y-axis and 'Stroke' on the x-axis, showing a straight line passing through the origin.</p>	 <p>A graph with 'Stroke' on the y-axis and 'Signal' on the x-axis, showing a curve that starts flat and then rises steeply.</p>	 <p>A graph with 'v' on the y-axis and 'Signal' on the x-axis, showing a curve that starts flat and then rises steeply, labeled '= %'.</p>

**☑ Dismantling protection**

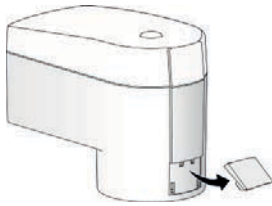

The HERZ Motor Valve Drives can be protected against unauthorised access simply by removing the locking latch.

**☑ LCD display 1 7708 42/46 & 5 7712 08/46**



The LCD display of the HERZ Motor Valve Drives alternately serve for displaying the stroke, including the current operating mode (opening/closing), the control voltage and also possible error codes.

**☑ Manual stroke setting 1 7708 40, 1 7708 42/46 and 5 7712 08/46**

The manual stroke setting allows to bring the valve pressure plate to the desired position in de-energized state. This facilitates maintenance and dismantling.



Remove the connection line and the protector plug. \*)

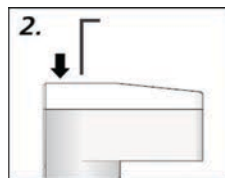

Insert a 4 mm allen key into the manual stroke setting device.

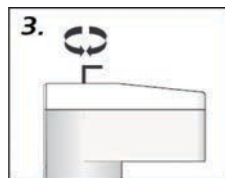

Turn to the right or left for extracting or retracting, respectively.

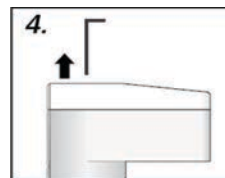

Remove the allen key after reaching the desired position.

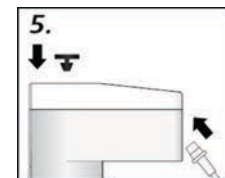

Install the protector plug and connect the connection line.

**☑ Manual stroke setting 1 7708 41**

The manual stroke setting allows to bring the valve pressure plate to the desired position in de-energized state. This facilitates maintenance and dismantling.

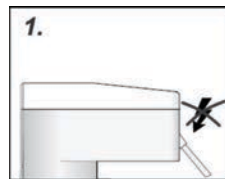

De-energize the actuator.

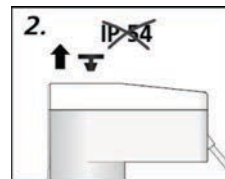

Remove the protector plug. \*)

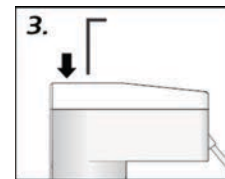

Insert a 4 mm allen key into the manual stroke setting device.

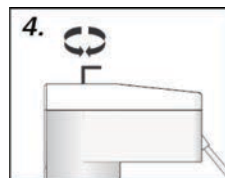

Turn to the right or left for extracting or retracting, respectively.

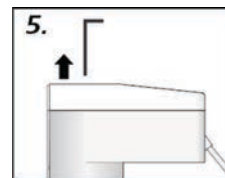

Remove the allen key after reaching the desired position.

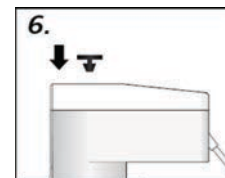

Install the protector plug.

\*) After removal of the connection cable and the protective plug, the protection class IP 54 cannot be guaranteed.

☑ **Installation 1 7708 40, 1 7708 42/46 and 5 7712 08/46.**

The valve adapter assortment guarantees a perfect mechanical match of the actuator to almost all valve bottoms and heating circuit distributors available on the market. The HERZ Motor Valve Drives are simply plugged onto the valve adapter, which is previously installed manually. The fact that the valve pressure plate is retracted in factory, allows for an easy installation.

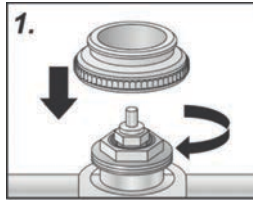

1. Screw the valve adapter manually onto the valve.

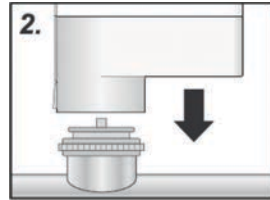

2. Position the actuator manually in vertical position to the valve adapter.



3. Simply latch the actuator to the valve adapter manually by applying vertical pressure; a clicking sound can be heard.

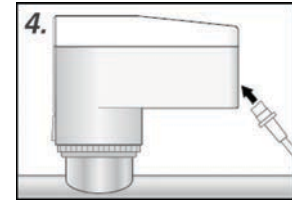

4. Connect the connection line to the actuator.

☑ **Installation 1 7708 41**

The wide selection of valve adapters guarantees a perfect match of the HERZ Motor Valve Drive to almost any valve bottom or manifold available on the market. Simply snap-on the HERZ Motor Valve Drive to the manually pre-installed valve adapter.

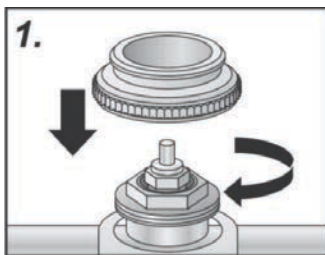

1. Screw the valve adapter manually onto the valve.

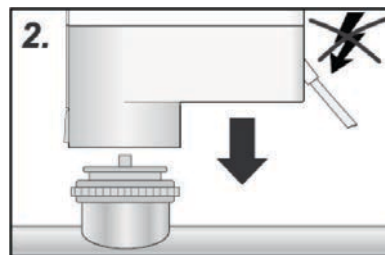

2. Position the actuator in de-energized state manually in vertical position to the valve adapter.

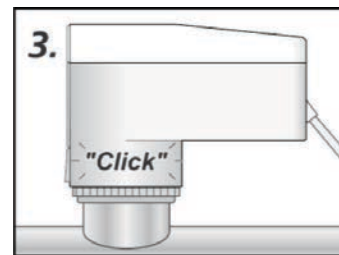

3. Simply latch the actuator to the valve adapter manually by applying vertical pressure; a clicking sound can be heard. Switch on the power supply in the connection.

☑ **Adapter for Motor Valve Drives**

- 1 **7708 90** Colour red, adapter M28 x 1,5 for the use with HERZ - heating circuit distributors and M28 x 1,5 HERZvalves
- 1 **7708 85** Colour blue, adapter M28 x 1,5 for HERZ 4002 and 4006
- 1 **7708 86** Colour light gray, adapter for the use with thermostatic valves, M30 x 1,5
- 1 **7708 80** Colour gray, adapter for the use with 7217-TS-E, M28 x 1,5
- 1 **7708 98** Adapter for the use with 7760, 7762, 7763, M30 x 1,5

☑ **Installation position**

The HERZ Motor Valve Drives can be operated in every installation position.

The horizontal or vertical installation position should be preferred. In case of **“overhead”** installation, special circumstances (e. g. drain water) can reduce the lifetime of the actuator.

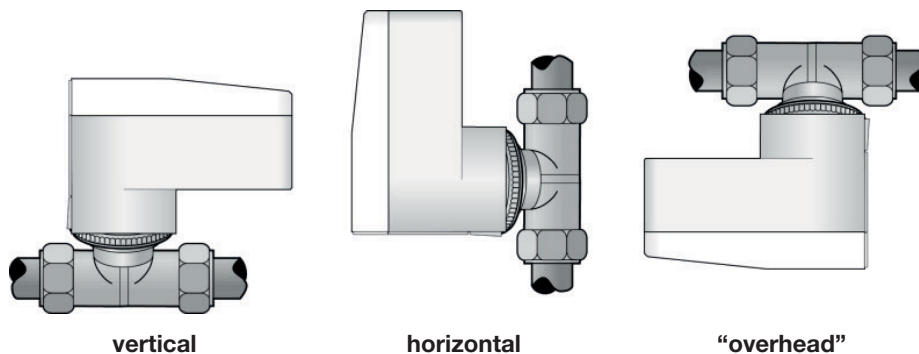

#### ☑ Technical data 1 7708 40

Operating voltage	24 V AC, -10% ... +20%, 50 - 60 Hz - 24 V DC, -20% ... +20%
Operating power	2,4 W
Max. power consumption	< 100 mA
Standby power consumption	< 10 mA (in end position)
Stroke	max. 8,5 mm
Actuating force	200 N +10%
Actuating time	30 s/mm
Fluid temperature	0 °C to +100 °C <sup>1)</sup>
Storage temperature	-20 °C to +70 °C
Ambient temperature	0 °C to +50 °C
Degree of protection / Protection class	IP 54 <sup>2)</sup> / III
CE conformity	according to EN 60730
Housing material/colour	Polyamide / white
Housing cover material/colour	Polycarbonate / transparent
Connection cable/colour	3 x 0,22 mm <sup>2</sup> PVC / white
Cable length	1 m
Weight with connection cable (1 m)	155 g
Surge strength according to EN 60730-7	min. 1 kV

1) in dependence of the adapter even higher - 2) in all installation positions

#### ☑ Technical data 1 7708 41

Operating voltage	230 V AC, -10% ... +10%, 50 Hz
Operating power	3,5 W
Max. power consumption	< 20 mA
Standby power consumption	< 5 mA
Stroke	max. 8,5 mm (minus 0,5 mm over-elevation)
Actuating force	200 N +10%
Actuating time	30 s/mm
Fluid temperature	0 °C to +100 °C <sup>1)</sup>
Storage temperature	-20 °C to +70 °C
Ambient temperature	0 °C to +50 °C
Degree of protection / Protection class	IP 54 <sup>2)</sup> / II
CE conformity	according to EN 60730
Housing material/colour	Polyamide / white
Housing cover material/colour	Polycarbonate / transparent
Connection cable/colour	3 x 0,75 mm <sup>2</sup> PVC / light grey (RAL 7035)
Cable length	1 m
Weight with connection cable (1 m)	155 g
Surge strength according to EN 60730-7	min. 2,5 kV

1) in dependence of the adapter even higher - 2) in all installation positions

#### ☑ Technical data 1 7708 42/46 & 5 7712 08/46

Operating voltage	24 V AC, -10% ... +20%, 50 - 60 Hz - 24 V DC, -20% ... +20%
Operating power	2,4 W
Max. power consumption	< 100 mA
Standby power consumption Resistance of control voltage input	< 10 mA
Feedback signal	100 kΩ
Stroke	0-10Vdc ( <b>1 7708 46 / 5 7712 46</b> )
Actuating force	max. 8,5 mm (minus 0,5 mm over-elevation)
	200 N +10% ( <b>1 7708 42/46</b> )
	125 N +10% ( <b>5 7712 08/46/48</b> )
Actuating time	30 s/mm
Fluid temperature	0 °C to +100 °C <sup>1)</sup>
Storage temperature	-20 °C to +70 °C
Ambient temperature	0 °C to +50 °C
Degree of protection / Protection class	IP 54 <sup>2)</sup> / III
CE conformity	according to EN 60730
Housing material/colour	Polyamide / white
Housing cover material/colour	Polycarbonate / transparent
Connection cable/colour	3 x 0,22 mm <sup>2</sup> PVC / white
Cable length	1 m
Weight with connection cable (1 m)	155 g
Surge strength according to EN 60730-7	min. 1 kV

1) in dependence of the adapter even higher - 2) in all installation positions

### ☑ Electric connection 1 7708 40

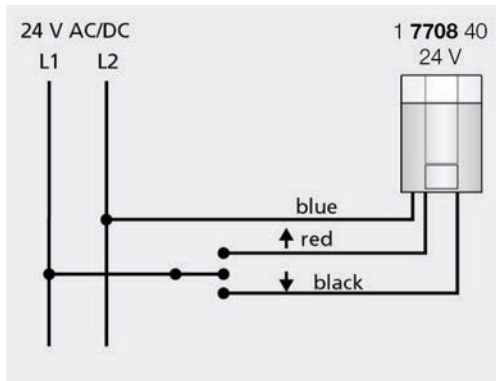

Voltage at red: actuator opens  
 Voltage at black: actuator closes  
 No voltage at red/black: actuator remains in current position

We recommend the following cable lengths for installing a 24 V system:

Cable	Section	Length
Standard DDC line	0,22 mm <sup>2</sup>	20 m
J-Y(ST)Y	0,8 mm	45 m
NYM / NYIF	1,5 mm <sup>2</sup>	136 m

#### Transformer / power supply:

A safety isolating transformer according to EN 61558-2-16 (for AC type) or a switching power supply according to EN 61558-2-16 (for DC type) must always be used

The dimensioning of the transformer or the switching power supply results from the making capacity of the HERZ Motor Valve Drives.

Rule-of-thumb formula:  $P_{\text{transformer}} = 6 \text{ W} \times n$   
 n = Number of HERZ actuators

### ☑ Electric connection 1 7708 41

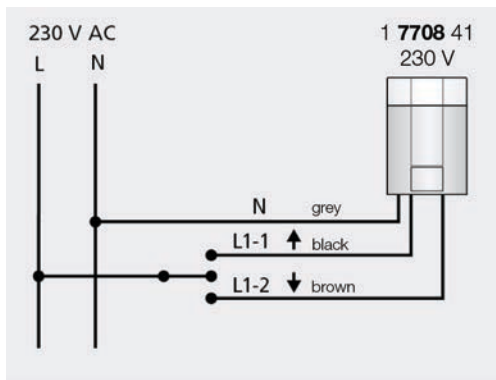

Voltage at L1-1: actuator opens  
 Voltage at L1-2: actuator closes  
 No voltage at L1-1/L1-2: actuator remains in current position

We recommend the following cables for installing a 230 V system:

Light plastic-sheathed cable: NYM 1,5 mm<sup>2</sup>  
 Flat webbed building wire: NYIF 1,5 mm<sup>2</sup>

### ☑ Electric connection 1 7708 42 / 5 7712 08

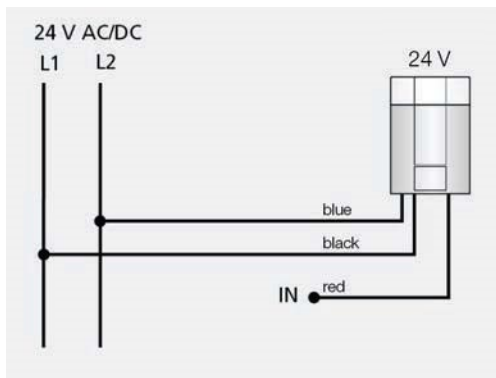

We recommend the following cable lengths for installing a 24 V system:

Cable	Section	Length
Standard DDC line	0,22 mm <sup>2</sup>	20 m
J-Y(ST)Y	0,8 mm	45 m
NYM / NYIF	1,5 mm <sup>2</sup>	136 m

#### Transformer / power supply:

A safety isolating transformer according to EN 61558-2-16 (for AC type) or a switching power supply according to EN 61558-2-16 (for DC type) must always be used

The dimensioning of the transformer or the switching power supply results from the making capacity of the HERZ Motor Valve Drives.

Rule-of-thumb formula:  $P_{\text{transformer}} = 6 \text{ W} \times n$   
 n = Number of HERZ actuators

☑ **Electric connection 1 7708 46 / 5 7712 46**

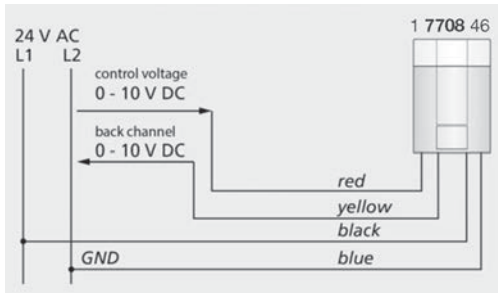

We recommend the following cable lengths for installing a 24 V system:

Cable	Section	Length
Standard DDC line	0,22 mm <sup>2</sup>	20 m
J-Y(ST)Y	0,8 mm	45 m
NYM / NYIF	1,5 mm <sup>2</sup>	136 m

**Transformer/power supply:**

A safety isolating transformer according to EN 61558-2-6 (for AC supply) or a switching power supply according to EN 61558-2-16 (for DC supply) must always be used.

The dimensioning of the transformer, or the switching power supply, results from the maximum operating power of the OEM Actuators.

Rule-of-thumb formula:  $P_{\text{transformer}} = 3 \text{ W} \times n$   
 $n = \text{Number of OEM Actuators}$

☑ **Accessories**

**1 7796 04 HERZ Transformer 230/24 V**

The overload-proof HERZ safety transformer 230/24 V is designed for the connection of HERZ room thermostats and HERZ actuating drives and suitable for operation of 8 HERZ actuating drives max.

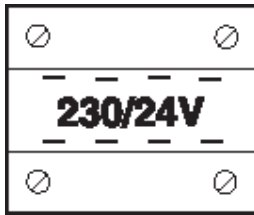

Version	as per VDE 0551
Protection class	II
Protection class	IP 20
ISO Cl.	T40/E
Input voltage	230 V
Fuse in input circuit	50-60 Hz, 315 mA
Output voltage	24 V
Power	50 VA
Quick installation on device rail	ref. DIN 42227/3
Dimensions	106 x 90 x 74 mm (B x H x T)

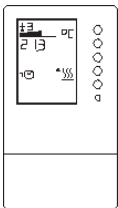

**1 7794 23 HERZ Electronic heating controller with PI behavior**

with programmable time and temperature adjustment. For motor drives at valves or mixers and for one pump (ON/OFF signal). Adjustment corresponding to external or room temperature by external or room temperature sensor. Easy adjustment with system by module switch and service parameter. Electronics located in the attachable body, white (RAL 9010), front panel with keypad and digital displays in viewing window. Digital timer with weekly and yearly programs, relay with operating hours counter.

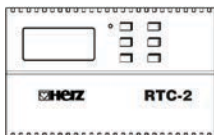

**1 7940 62 HERZ-RTC-2 Room Temperature Computer**

With 3 weekly programmes, 4 temperature steps, vacation programme for heating and cooling, switching difference adjusting. Set value range 5–40 °C, operating voltage 24 V, output voltage 0–10 V.